



SHD Series

STEREO HIGH-DEFINITION ROOM CORRECTION PROCESSOR AND CROSSOVER

Featuring Dirac Live® Room Correction Technology
and Volumio network streaming

SHD

SHD Studio



User Manual



Revision history

Revision	Description	Date
0.1	First draft	26 March 2018
0.6	Preliminary for public release	12 June 2018
1.0	Public release	29 June 2018
1.1	Updates to front panel, firmware update, minor corrections	17 August 2018
1.2	Correction to remote operation	18 August 2018
1.3	Minor corrections	21 August 2018
1.4a	Additional information for Volumio and USB audio	29 August 2018
1.5	Updated for new Volumio release	22 November 2018
1.6	Added plugin for Spotify, software updates	17 December 2018
1.7	Harmony remote codes, iOS/Android app control	15 January 2018

TABLE OF CONTENTS

Table of Contents	3
IMPORTANT INFORMATION	6
1 Product Overview	9
1.1 Dirac Live	10
1.2 Better connectivity	11
1.3 Network streaming.....	11
1.4 Front panel display and remote control.....	12
1.5 Powerful back-end processing	12
2 Hardware Overview	13
2.1 Rear panel connections – SHD.....	13
2.2 Rear and front panel connections – SHD Studio	14
2.3 Front panel controls and display	15
3 Remote control	16
3.1 Using the miniDSP remote	16
3.2 Programming a Logitech Harmony remote	17
3.3 Android/iOS control app.....	17
3.4 Alexa voice control	18
3.5 Learning third-party remote codes	18
4 Software Overview.....	19
4.1 Configuration steps for stereo room correction	19
4.2 Configuration steps with advanced/back-end processing	20
5 Playing Audio / Quick-start Guide.....	21
5.1 Basic connections and audio – SHD.....	21
5.2 Basic connections and audio – SHD Studio	22
5.3 USB Audio	23
5.3.1 macOS / OS X.....	23
5.3.2 Windows.....	24
5.4 Network audio	26
5.4.1 Getting connected.....	26
5.4.2 Web interface	27
5.4.3 Playing from USB stick.....	28
5.4.4 TIDAL and Qobuz	29
5.4.5 Spotify streaming.....	30
5.4.6 Using multiple SHD Series processors	31
6 Software Installation.....	32
6.1 Download the software.....	32
6.2 Software installation — Windows.....	33
6.3 Software installation — macOS / OS X.....	35

- 7 Acoustic Measurement for Dirac Live 36
 - 7.1 Loudspeaker and microphone positioning 36
 - 7.2 Preparing for acoustic measurement 37
 - 7.3 Configuring for measurement 38
 - 7.3.1 Check your configuration/preset (advanced) 39
 - 7.3.2 Sound System tab 39
 - 7.3.3 Mic Config tab 40
 - 7.3.4 Output & Levels tab 41
 - 7.4 Running the measurements 42
 - 7.4.1 Listening environment 43
 - 7.4.2 Executing measurements 44
 - 7.4.3 Viewing and redoing measurements 44
 - 7.4.4 Completing the measurements 45
 - 7.5 Saving and loading projects 45
- 8 Dirac Live Filter Design and Download 46
 - 8.1 Working with graphs 46
 - 8.2 Designing your target curve 48
 - 8.2.1 The Auto Target 48
 - 8.2.2 Editing the target curve 49
 - 8.2.3 Guidelines for target curve design 50
 - 8.2.4 Saving and loading target curves 51
 - 8.3 Generating correction filters 51
 - 8.4 Loading filter sets 52
- 9 Configuring backend processing 53
 - 9.1 How it works 53
 - 9.2 Plugin user interface 54
 - 9.3 Connecting to the processor 55
 - 9.4 Key features 56
 - 9.4.1 Master control 56
 - 9.4.2 Configuration/preset selection 56
 - 9.4.3 Inputs 57
 - 9.4.4 Input selection 57
 - 9.4.5 Matrix mixer 57
 - 9.4.6 Outputs 58
 - 9.5 Acoustic measurement for back-end configuration 59
 - 9.5.1 Using DLCT as a measurement tool 59
 - 9.5.2 Using Room EQ Wizard 59
 - 9.6 Sample plugin configurations 60
 - 9.6.1 Stereo room correction 60
 - 9.6.2 Add single subwoofer 61
 - 9.6.3 Add dual subwoofers 62
 - 9.6.4 Stereo supporting woofers/FAST 63
 - 9.6.5 Two-way active speaker 64

10	Plugin Reference	65
10.1	Input channel status	65
10.2	Routing	65
10.3	Output channels	66
10.3.1	Channel label	66
10.3.2	Level metering and gain adjustment	66
10.3.3	Parametric EQ	67
10.3.4	Crossover	69
10.3.5	Compressor	71
10.3.6	Invert and mute	71
10.3.7	Time delay	72
10.4	Custom biquad programming	72
10.4.1	What's a "biquad?	72
10.4.2	Using custom biquad programming	73
10.4.3	Biquad design software	74
10.5	Working with configurations	75
10.5.1	Online and offline mode	75
10.5.2	Selecting a configuration	75
10.5.3	Saving and loading configurations	76
10.5.4	Relationship with Dirac Live	76
10.5.5	Restoring to defaults	77
10.6	Keyboard shortcuts	77
11	Additional Information	78
11.1	Specifications	78
11.1.1	All SHD Series processors	78
11.1.2	SHD	79
11.1.3	SHD Studio	80
11.2	Plugin and DSP upgrade	81
11.3	Volumio software update	82
11.4	Firmware upgrade	83
11.4.1	Windows	83
11.4.2	macOS / OS X	85
11.5	Troubleshooting	87
11.5.1	SHD plugin	87
11.5.2	DLCT	88
11.6	Obtaining support	89
11.7	Open source licenses	89



IMPORTANT INFORMATION

Please read the following information before use. In case of any questions, please contact miniDSP via the support portal at minidsp.desk.com.

System Requirements

To configure the miniDSP audio processor, you will require a Windows PC or Apple Mac OS X computer with the following minimum specification:

Windows

- Intel Pentium III or later, AMD Athlon XP or later
- 2 Gigabytes (GB) of RAM or higher
- Keyboard and mouse or compatible pointing device
- Microsoft® Windows® Vista® SP1/Win7/Win8/Win10
- Two free USB 2.0 ports

macOS / OS X

- Intel-based Mac with 1 GHz or higher processor clock speed
- 2 Gigabytes (GB) of RAM or higher
- Keyboard and mouse or compatible pointing device
- OS X 10.9 (Mavericks) or later, macOS 10.12 (Sierra) or later
- Two free USB 2.0 ports

Disclaimer/Warning

miniDSP cannot be held responsible for any damage that may result from the improper use of this product or incorrect configuration of its settings. As with any other product, we recommend that you carefully read this manual and other technical notes to ensure that you fully understand how to operate this product. The miniDSP audio processor is a powerful tool, and misuse or misconfiguration, such as incorrectly set gains or excessive boost, can produce signals that may damage your audio system.

As a general guideline, you should perform the initial configuration of the miniDSP audio processor before enabling audio through any connected output device or amplification. Doing so will help ensure that the software is correctly configured.

Finally, note that the miniDSP audio processor is a very flexible device, and many of the questions we receive at the tech support department are already answered in this user manual and in the online [application notes](#) on the miniDSP.com website. So please take the time to carefully read this user manual and the online technical support. Thanks for your understanding!



Warranty Terms

miniDSP Ltd warrants this product to be free from defects in materials and workmanship for a period of one year from the invoice date. Our warranty does not cover failure of the product due to incorrect connection or installation, improper or undocumented use, unauthorized servicing, modification or alteration of the unit in any way, or any usage outside of that recommended in this manual. If in doubt, contact miniDSP prior to use.

FCC Class B Statement

This device complies with Part 15 of the FCC Rules. Operation is subject to the following two conditions:

- This device may not cause harmful interference.
- This device must accept any interference received, including interference that may cause undesired operation.

Warning: This equipment has been tested and found to comply with the limits for a Class B digital device, pursuant to Part 15 of the FCC Rules. These limits are designed to provide reasonable protection. This equipment generates, uses and can radiate radio frequency energy and, if not installed and used in accordance with the instructions, may cause interference to radio communications. However, there is no guarantee that interference will not occur in a particular installation. If this equipment does cause harmful interference to radio or television reception, which can be determined by turning the equipment off and on, the user is encouraged to try to correct the interference by one or more of the following measures:

- Reorient or relocate the receiving antenna.
- Increase the separation between the equipment and receiver.
- Connect the equipment into an outlet on a circuit different from that to which the receiver is connected.
- Consult the dealer or an experienced radio/TV technician for help.

Notice: Shielded interface cable must be used in order to comply with emission limits.

Notice: Changes or modification not expressly approved by the party responsible for compliance could void the user's authority to operate the equipment.

CE Mark Statement

The miniDSP SHD Series processor has passed the test performed according to European Standard EN 55022 Class B.

A note on this manual

This User Manual is designed for reading in both print and on the computer. If printing the manual, please print double-sided. The embedded page size is 8 ½” x 11”. Printing on A4 paper will result in a slightly reduced size.

For reading on the computer, we have included hyperlinked cross-references throughout the manual. In addition, a table of contents is embedded in the PDF file. Displaying this table of contents will make navigation much easier:

- In Adobe Reader on Windows, click on the “bookmarks” icon at the left. The table of contents will appear on the left and can be unfolded at each level by clicking on the “+” icons.
- In Preview on the Mac, click on the **View** menu and select **Table of Contents**. The table of contents will appear on the left and can be unfolded at each level by clicking on the triangle icons.

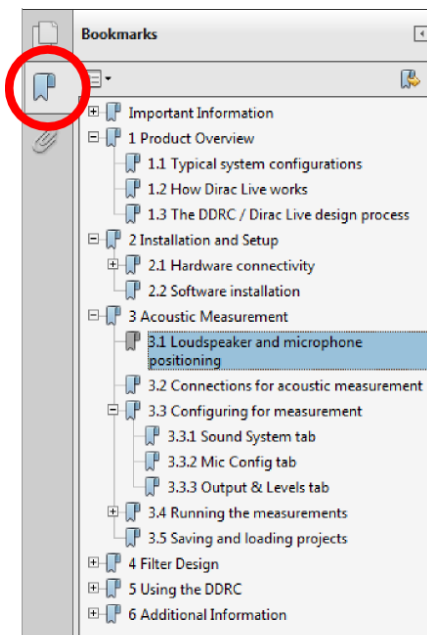

Adobe Reader on Windows

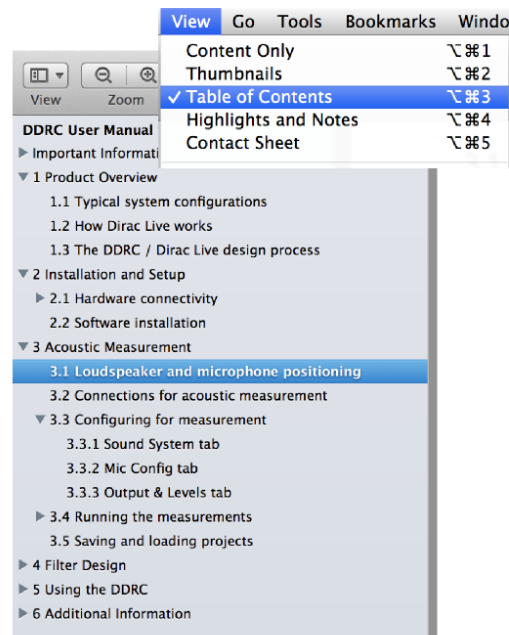

Preview on Mac

1 PRODUCT OVERVIEW

Thank you for purchasing a miniDSP SHD Series high-resolution¹ room correction processor powered by Dirac Live®, the world’s premier room correction solution. The new SHD Series offers a wealth of input-output options, powerful back-end processing for subwoofer integration and active systems, and of course Dirac Live. As is our custom, the series includes a range of models for optimum matching to different applications.

Key features

- Analog input on RCA and XLR (SHD only)
- Analog output on RCA and XLR (SHD only)
- Digital inputs – SPDIF, TOSLINK, AES-EBU
- USB Audio streaming up to 192 kHz
- Network streaming up to 192 kHz
- Dirac Live room correction
- Bright front panel display
- Included basic remote control
- Support third-party remotes
- Supports iOS/Android remote app²
- Supports voice control with Amazon Alexa²
- Powerful back-end processing

Inputs

Analog RCA
Analog XLR

SPDIF, TOSLINK, AES-EBU
USB Audio
Network Audio

Outputs

Analog RCA (4 channels)
Analog XLR (4 channels)

SPDIF x 2 (4 channels)



SHD

Full-featured network streamer with Dirac Live digital room correction. Lots of analog and digital inputs and outputs, plus powerful backend/crossover processing.

Inputs

SPDIF, TOSLINK, AES-EBU
USB Audio
Network audio

Outputs

SPDIF x 2 (4 channels)
AES/EBU x 2 (4 channels)

SHD Studio

Specialized network streamer with digital I/O. Includes Dirac Live stereo room correction, 4-channel digital out, and powerful backend/crossover processing.



¹ The miniDSP SHD Series processors operate with 32-bit 96 kHz resolution.

² A [miniDSP Wi-DG](http://www.minidsp.com) is required (optional purchase). Amazon Alexa functionality requires an Amazon Echo.

1.1 DIRAC LIVE

Each SHD Series processor executes Dirac Live® digital room correction, from [Dirac Research](https://www.diracresearch.com). Dirac Live’s mixed-phase filtering technology will improve the imaging of your system, minimize the effects of room modes and resonances, and improve dynamics and clarity.

To accomplish its remarkable improvement in listening quality, the **Dirac Live Calibration Tool (DLCT)** steps you through the procedure for taking measurements around your listening area. Dirac Live® employs a sophisticated analysis algorithm to make the optimal correction across the *whole* listening area, not just at a single point. The user has full control over the target response. Measurements are taken with a calibrated acoustic measurement microphone, the miniDSP UMIK-1.³

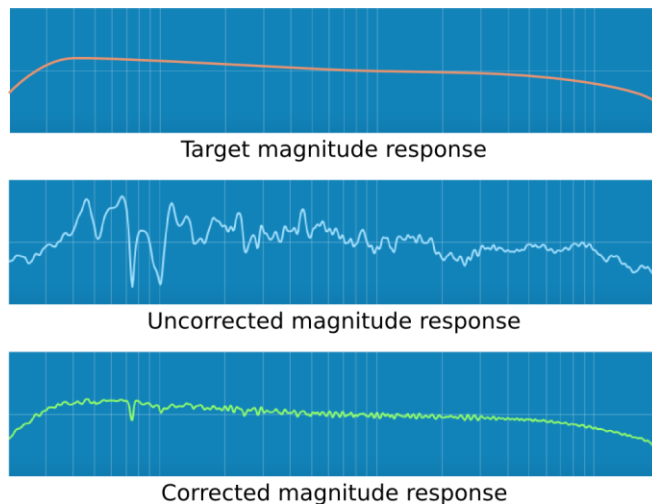

In addition to correcting magnitude response, Dirac Live® corrects the system’s *impulse response*, which reflects how the system responds to a sharp transient such as a drumbeat. Reflections, diffraction, resonances, misaligned drivers, and so on, all combine to smear out the transient. Correcting the impulse response makes the speaker in the room behave much more like an ideal loudspeaker. The impulse response is a critical factor for accurate sound-staging, clarity and bass reproduction.

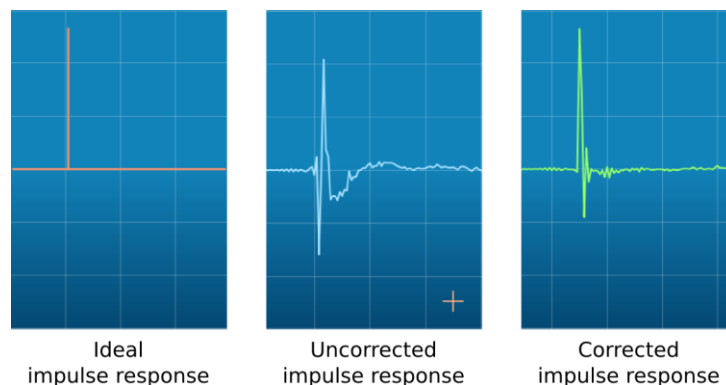

³ A UMIK-1 is included in the standard purchase price of each SHD Series processor. Other microphones cannot be used.

1.2 BETTER CONNECTIVITY

We've listened to our customers who wanted more input-output connectivity and flexibility. Our flagship SHD processor sports balanced (XLR) and unbalanced (RCA) analog inputs, three digital inputs (SPDIF coax, TOSLINK, and AES-EBU), USB audio streaming, and a network port for audio streaming.

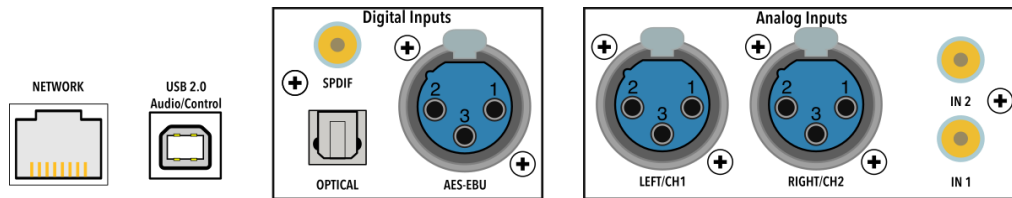

On the output side, there are four output channels, all available as balanced analog (XLR), unbalanced analog (RCA) and SPDIF coax digital.

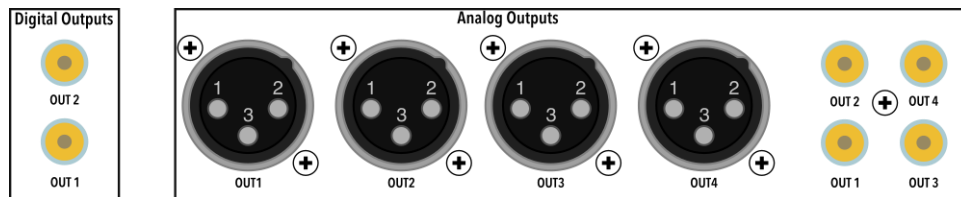

1.3 NETWORK STREAMING

miniDSP has previously supported the professional AVB (Audio-Video Bridging) protocol. For home systems, the SHD Series processors incorporate popular network streaming protocols for the first time. They ship with a custom version of the popular network streaming endpoint [Volumio](#), which supports multiple methods of playing networked audio, including online streaming services TIDAL, Qobuz and Spotify.

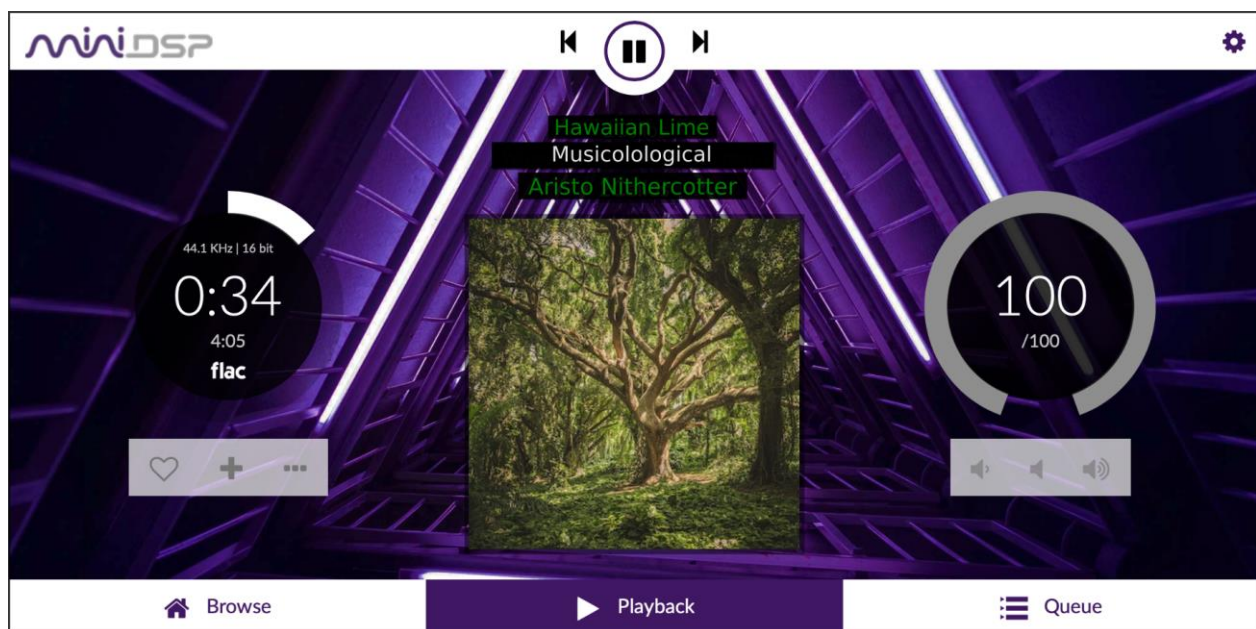

1.4 FRONT PANEL DISPLAY AND REMOTE CONTROL

The SHD Series processors provide essential status and control information on a newly-designed front panel display. The included basic miniDSP remote control provides easy access to the main user operations, including volume control, room correction preset selection, source selection, mute, and Dirac Live on/off. Remote control can also be accomplished with third-party remotes, an iOS/Android app, and Amazon Alexa voice control.



1.5 POWERFUL BACK-END PROCESSING

In addition to Dirac Live, SHD Series processors include a powerful set of additional functions, controlled by miniDSP's well-known and easy-to-use software interface. Flexible routing from the inputs through to the outputs allows applications such as integration of one or two subwoofers and two-way active speakers. The SHD Series processors are compatible with powerful tools such as [Room EQ Wizard](#) and [MultiSub Optimizer](#).

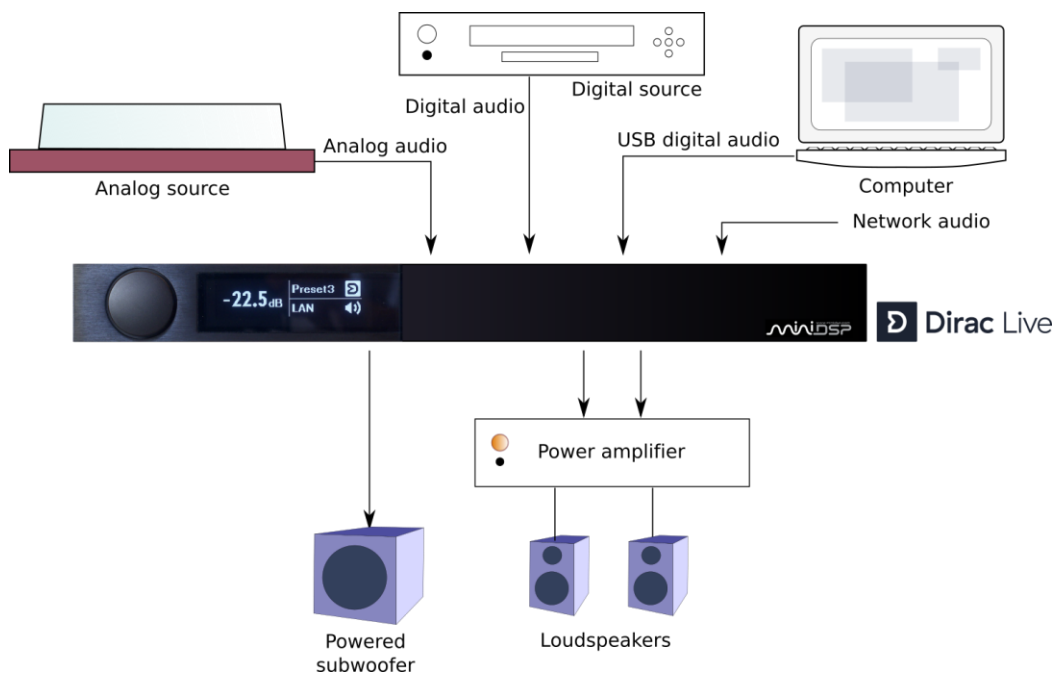
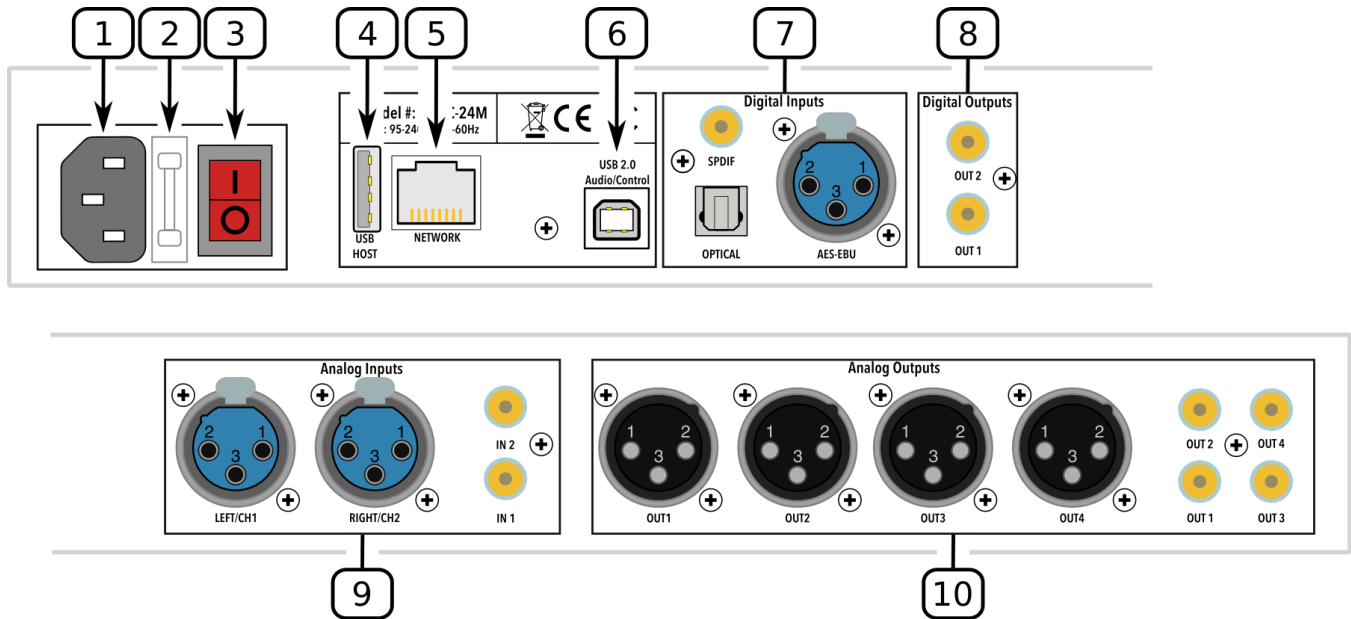

Figure 1. Typical audio system configuration using the SHD processor

2 HARDWARE OVERVIEW

2.1 REAR PANEL CONNECTIONS – SHD



1. **Power inlet.** Connect a standard IEC C13 cable here.
2. **Fuse holder.** If the fuse needs replacing, remove the power cable. Then use a small flat-bladed screwdriver to lever out the fuse and fuse holder. Replace the fuse with a 250V rated 4A fuse and push the fuse holder firmly back in.
3. **Power switch.**
4. **Host port** for USB music sticks.
5. **Ethernet port** for network music streaming.
6. **USB port** for control and audio streaming. Connect to an available USB port on your computer.
7. **Digital inputs.** Connect digital sources here using optical (TOSLINK SPDIF), coax (RCA SPDIF), or AES/EBU (XLR) connections. Sample rates from 32 up to 216 kHz are supported. The three digital inputs can be separately selected with the front panel encoder or the remote control.
8. **Digital outputs.** If you prefer to use your own DAC or DACs, connect them here using RCA SPDIF. Each DAC must be capable of running at 24-bit 96 kHz.
9. **Analog inputs.** Connect one or two analog sources here, using balanced XLR or unbalanced RCA connections. The two analog inputs can be separately selected with the front panel encoder or the remote control. See Specifications for maximum input voltages.
10. **Analog outputs.** Connect power amplifiers here using balanced XLR or unbalanced RCA connections. See Specifications for maximum output voltages.

2.2 REAR AND FRONT PANEL CONNECTIONS – SHD STUDIO

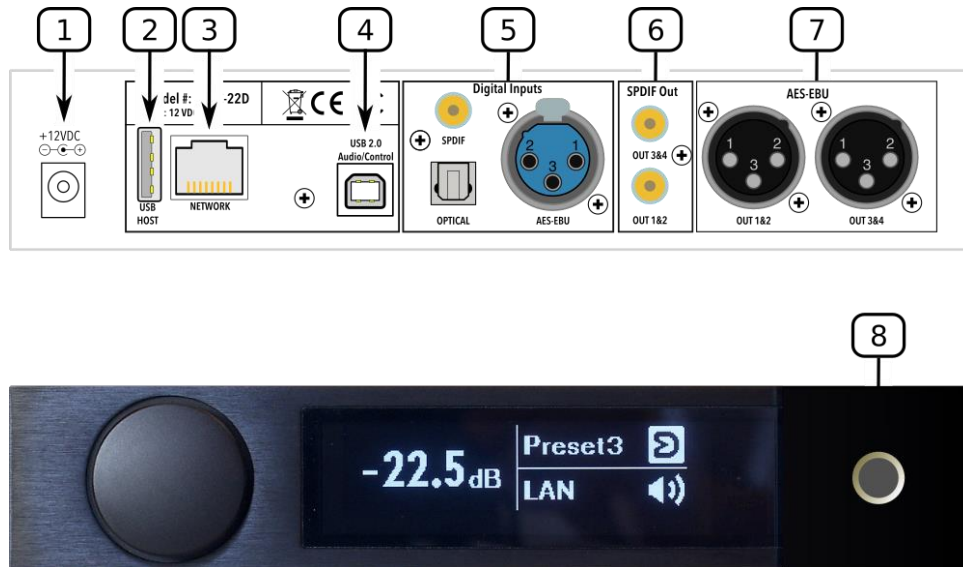

1. **DC power inlet.** Connect the supplied 12 VDC power supply here.
2. **Host port** for USB music sticks.
3. **Ethernet port** for network music streaming.
4. **USB port** for control and audio streaming. Connect to an available USB port on your computer.
5. **Digital inputs.** Connect digital sources here using optical (TOSLINK SPDIF), coax (RCA SPDIF), or AES/EBU (XLR) connections. Sample rates from 32 up to 216 kHz are supported. The three digital inputs can be separately selected with the front panel encoder or the remote control.
6. **SPDIF Out.** Connect external DACs with RCA cables here. Each DAC must be capable of running at 24-bit 96 kHz.
7. **AES-EBU.** Connect external DACs with XLR AES-EBU cables here. Each DAC must be capable of running at 24-bit 96 kHz.
8. **Headphone output.** The signal on this output jack follows output channels 3 and 4.

2.3 FRONT PANEL CONTROLS AND DISPLAY

The front panel display shows current volume, selected preset, input source, mute, and Dirac Live status.



- To change the volume, rotate the encoder knob. Volume changes in 0.5 dB steps. Minimum volume is -127.5 dB and maximum volume is 0.0 dB.
- To mute output, press and hold on the encoder knob. The speaker icon changes to have a line through it. To unmute, press and hold the encoder knob again.



Not muted

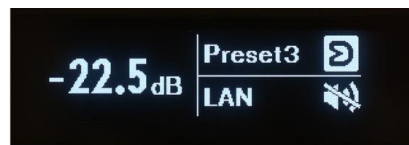

Muted

- To change the selected preset, press the encoder knob once, then rotate until the desired preset number is displayed. Either press the encoder again or wait for a second. The display will show “Pls wait...” while the new preset is being loaded. The display will then return to normal with the new preset number.
- To change input source, press the encoder knob twice. The display will change to show the current input source in large letters. Rotate the encoder knob until the desired input source is displayed, then press the encoder knob or wait for a second. The display will then return to normal with the new input displayed.
- To turn Dirac Live filtering on and off, press the encoder knob three times. The display will change to show either “Dirac On” or “Dirac Off” in large letters. Rotate the encoder knob until the desired selection (on or off) is displayed, then press the encoder knob or wait for a second. The display will return to normal with the Dirac Live status:

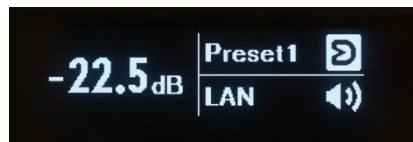

Dirac Live on

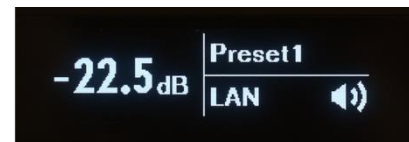

Dirac Live off

(Note: all these operations can also be performed with the remote control.)

3 REMOTE CONTROL

The miniDSP SHD has several options for remote control of key runtime functions, such as volume, mute, preset selection, and source selection.

3.1 USING THE MINIDSP REMOTE

The remote control provided with the processor controls all key runtime functions.

Source

Cycles through the input sources in order:

- SHD: RCA (unbalanced analog), XLR (balanced analog), USB, LAN (Ethernet), TOSLINK, SPDIF, AES-EBU
- SHD Studio: USB, LAN (Ethernet), TOSLINK, SPDIF, AES-EBU

1, 2, 3, 4

Switches to the selected preset. Note that it takes a few seconds for the preset selection to complete, while the processor loads the new filters from its flash memory into the DSP.

[Bell]

Enables or disables Dirac Live filtering. Dirac Live filtering will be effective only on presets for which Dirac Live filters have been loaded.

Vol

Reduce or increase the volume. Each press changes the volume in 0.5 dB. Holding down a button will accelerate volume change to 3 dB steps.

Mute

Mutes and unmutes audio output.



3.2 PROGRAMMING A LOGITECH HARMONY REMOTE

The miniDSP SHD can be used with a Logitech® Harmony® remote⁴. All the same functions as the stock remote are programmed into the Harmony database. In addition, you can set up buttons for direct input source selection (instead of cycling through input sources).

For more information, see this application note:

- [Using a Harmony Remote with the miniDSP SHD](#)



3.3 ANDROID/iOS CONTROL APP

With the addition of a [miniDSP Wi-DG](#) Wi-Fi to USB bridge, the SHD can be remote-controlled from a phone or tablet running Android or iOS (i.e. iPhone/iPad).

For more information, see this application note:

- [Using Android / iOS app to control your miniDSP](#)

If you're keen to just get started, here are the direct links to the app:

- [Android version on Google Play store](#)
- [iOS version on iTunes store](#)



If the USB port is being used for iOS/Android app control via the Wi-DG, it cannot be used for USB Audio streaming.

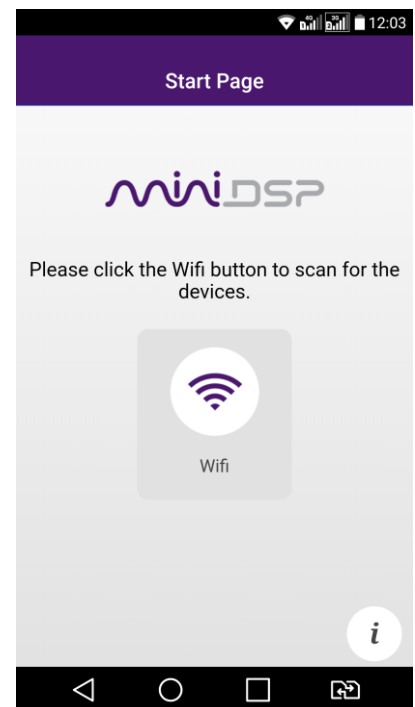

⁴ Logitech and Harmony are registered trademarks of Logitech.

3.4 ALEXA VOICE CONTROL

With the addition of a [miniDSP Wi-DG](#) Wi-Fi to USB bridge and an Amazon Echo, the SHD can be remote-controlled using voice control with Amazon Alexa.

For more information, see this application note:

- [Using Amazon Alexa with miniDSP Wi-DG](#)



If the USB port is being used for Alexa voice control via the Wi-DG, it cannot be used for USB Audio streaming.

3.5 LEARNING THIRD-PARTY REMOTE CODES

While each SHD Processor is supplied with a basic miniDSP remote, the SHD can also “learn” the control codes of a third-party remote if it supports one of the following remote control codes:

- Apple
- NEC
- Sony
- Philips RC6

To initiate the learning process, start the SHD plugin and click on the Connect button. Once connected, drop down the IR Remote menu and select **IR learning**. Click on the **Learn** button for an operation, and then press the desired button on the remote control. If the code is accepted, the status will change to show a tick. Repeat for all commands:

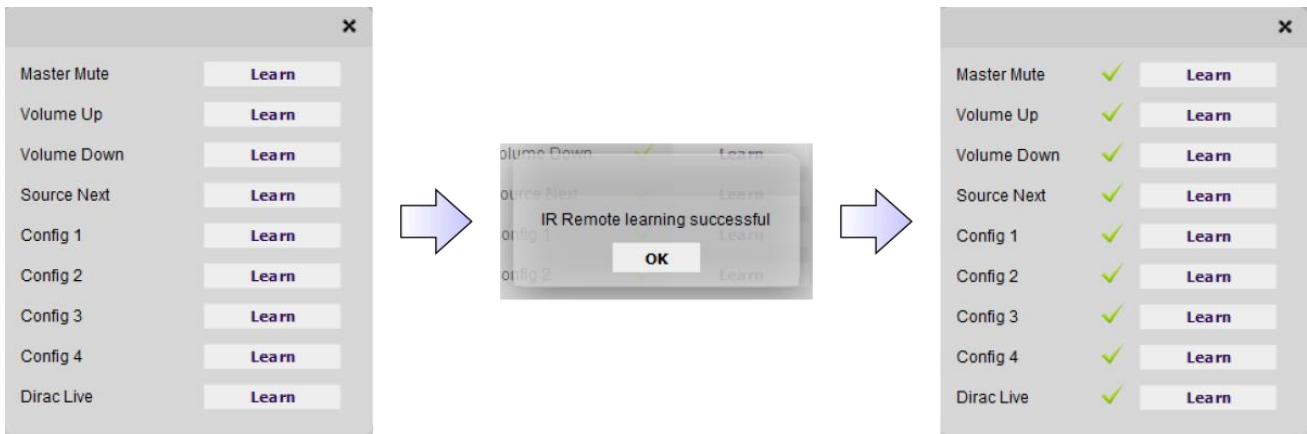

To “unlearn” a command, press the **Learn** button and wait for the plugin to time out. Note that you cannot “learn” the miniDSP remote – it will always work, even if you learn another remote’s codes.

4 SOFTWARE OVERVIEW

SHD Series processors are configured by software running on a PC or Mac. There are two programs: **Dirac Live Calibration Tool (DLCT)** and the **SHD plugin**. If you are interested in using the SHD Series processor for stereo room correction only, follow the steps on this page. If you wish to use the full processing features of the SHD Series, follow the steps on the next page.

4.1 CONFIGURATION STEPS FOR STEREO ROOM CORRECTION

Follow these steps to configure the SHD Series processor for stereo Dirac Live® room correction:

1. Connect the SHD Series processor into your system and install software. See Sections 5 and 6.

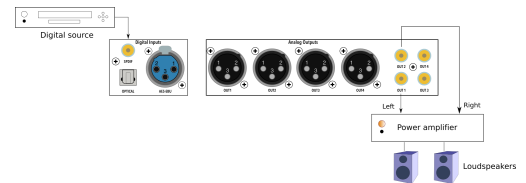

2. Run a series of acoustic measurements using the **Dirac Live Calibration Tool** program, to capture the acoustic behavior of your speakers and room. See Section 7.

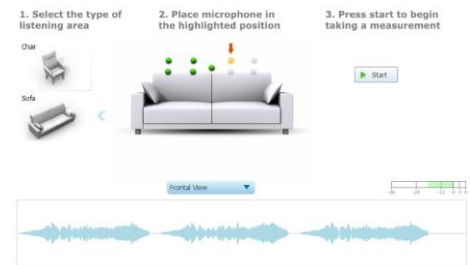

3. Generate digital room correction filters that will be executed by the *SHD* processor. Up to four filter sets can be downloaded into the processor for easy real-time recall and auditioning. See Section 8.

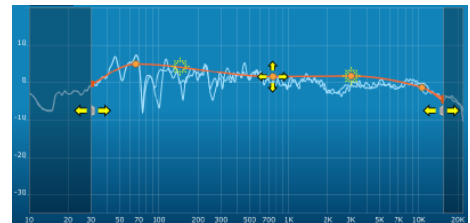

4. Once the digital room correction filters are designed and downloaded, the computer can be disconnected for normal listening. Or, use it to stream audio over USB to the SHD Series processor.

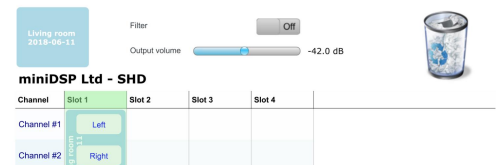

4.2 CONFIGURATION STEPS WITH ADVANCED/BACK-END PROCESSING

Follow these step for configure the SHD Series processor for applications such as subwoofer integration or active speakers, in addition to Dirac Live® room correction:

1. Connect the SHD Series processor into your system and install software. See Sections 5 and 6.

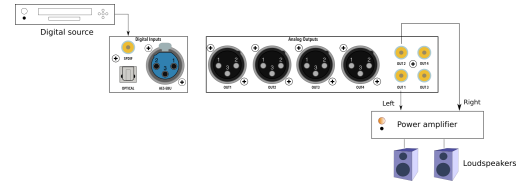

2. Configure back-end processing with the SHD plugin. This sets up individual control of each output channel in order to (for example) integrate a subwoofer or implement an active speaker. See Section 9.

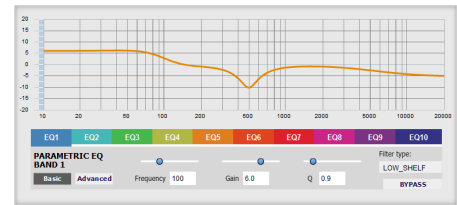

3. Run a series of acoustic measurements using the **Dirac Live Calibration Tool** program, to capture the acoustic behavior of your speakers and room. See Section 7.

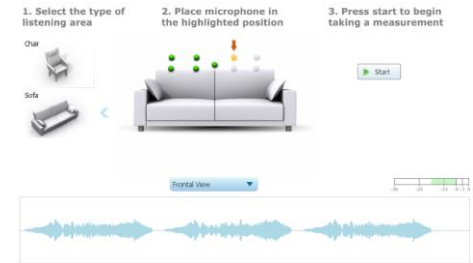

4. Generate digital room correction filters that will be executed by the SHD Series processor. Up to four filter sets can be downloaded into the processor for easy real-time recall and auditioning. See Section 8.

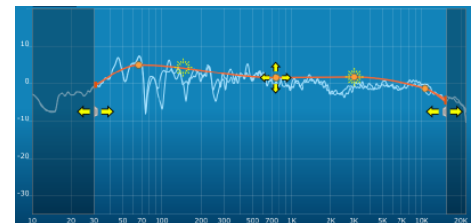

5. Once the digital room correction filters are designed and downloaded, the computer can be disconnected for normal listening. Or, use it to stream audio over USB to the SHD Series processor.

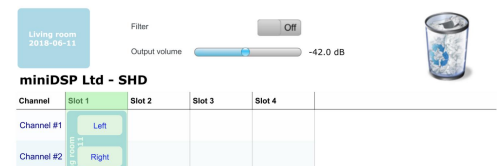

5 PLAYING AUDIO / QUICK-START GUIDE

Each SHD Series processor comes delivered ready-to-go for basic configurations. You can start playing audio straightaway, then move onto Dirac Live calibration and subwoofer integration.

5.1 BASIC CONNECTIONS AND AUDIO – SHD

The diagram below illustrates a typical example of a simple connection to use to get started with the SHD. Depending on the specific equipment that you have, you may use a different input, or use the balanced outputs instead of the RCA outputs.

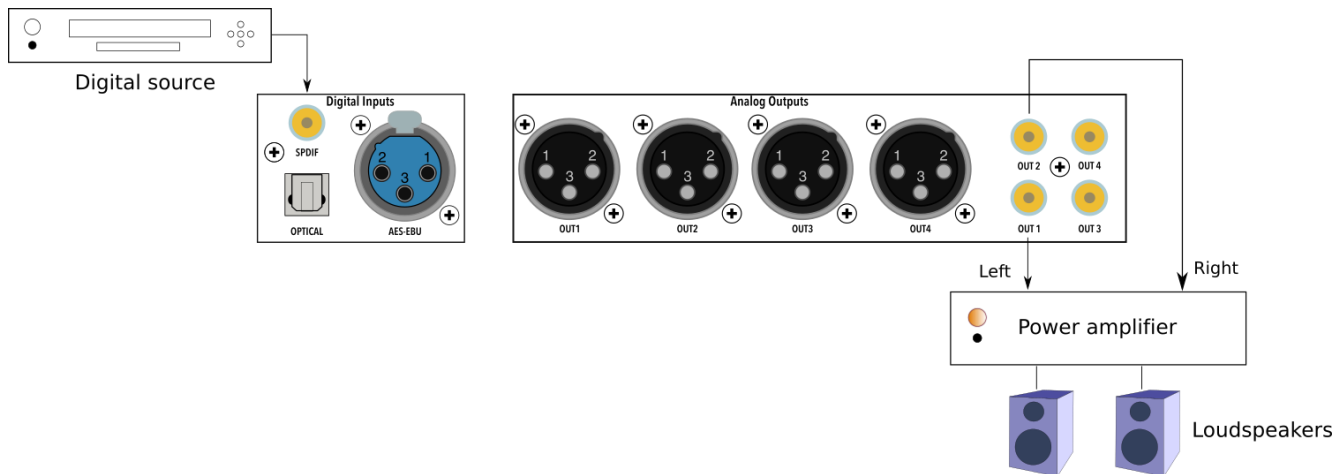

1. Connect an audio source to the rear panel.
2. Connect either the analog balanced (XLR) or unbalanced (RCA) outputs to a power amplifier. (Or, connect digital output for channels 1 and 2 to a DAC, then to a power amplifier – see the description on the next page for the SHD Studio for an example.)
3. Leave the power amplifier turned off for now. Connect the supplied power cable to the IEC socket on the rear panel of the SHD.
4. Power on the source equipment.
5. Switch power on using the switch at the rear panel. Wait a few seconds until the display shows the volume level. Use the knob or included remote control to turn volume down to -60 dB.
6. Use the remote control or front panel encoder to select the source that you want to play audio from.
7. Turn on the power amplifier.
8. Start playing audio on the source.
9. Gradually turn up the volume using the knob or the remote control.



Turn **off** the power to the SHD Series processor before making or changing audio connections.

5.2 BASIC CONNECTIONS AND AUDIO – SHD STUDIO

The diagram below illustrates a typical example of a simple connection to use to get started with the SHD. Depending on the specific equipment that you have, you may use a different input, or use the AES/EBU digital output instead of the SPDIF output.

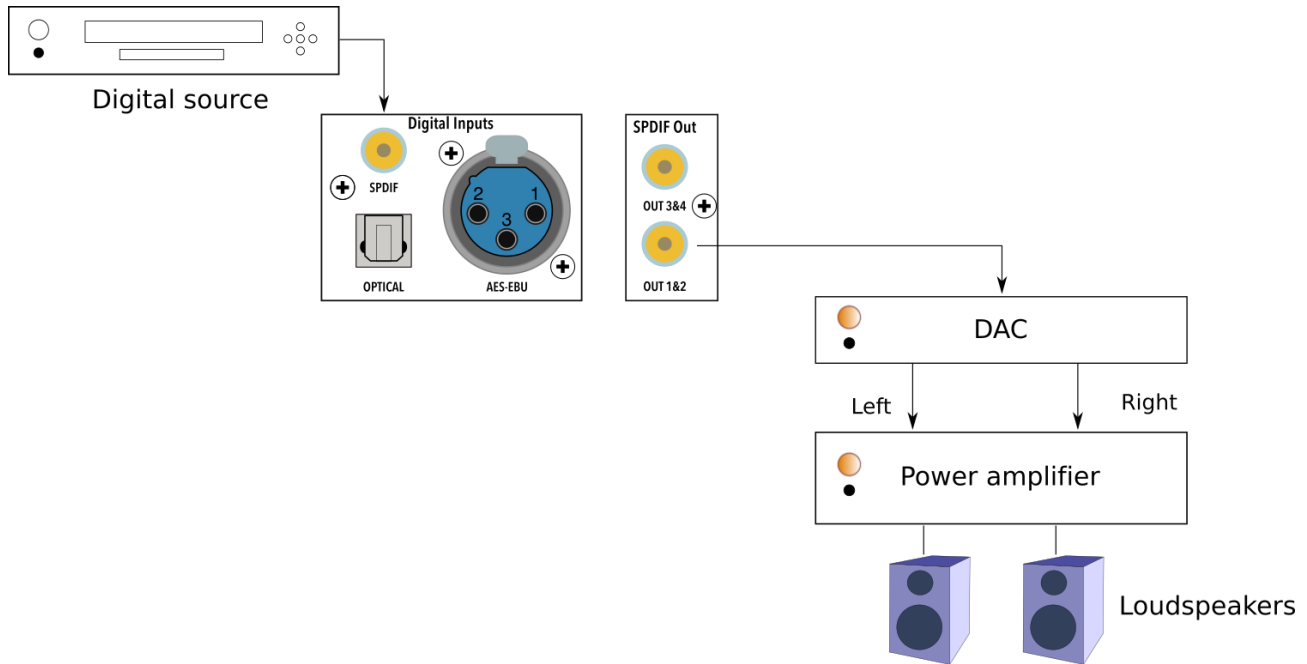

1. Connect an audio source to the rear panel.
2. Connect SPDIF Out 1&2 to your external DAC and connect the DAC outputs to your power amplifier. Alternatively, connect the SPDIF Out 1&2 to equipment with digital input and power amplification built-in, such as an A/V receiver or digital integrated amplifier.
3. Power on the source equipment.
4. Plug in the power to the SHD Studio. Wait a few seconds until the display shows the volume level. Use the knob or included remote control to turn volume down to -60 dB.
5. Use the remote control or front panel encoder to select the source that you want to play audio from.
6. Turn on the power amplifier, A/V receiver or integrated amplifier.
7. Start playing audio on the source.
8. Gradually turn up the volume using the knob or the remote control.



Turn **off** the power to the SHD Series processor before making or changing audio connections.

5.3 USB AUDIO

The miniDSP SHD Series processors accept stereo PCM audio at sample rates of 44.1, 48, 88.2, 96, 176.4, and 192 kHz over USB. The same USB connector is used both for streaming audio and configuration.

5.3.1 macOS / OS X

Open the program **Audio MIDI Setup** (in **Applications->Utilities**). Clicking on “SHD” in the list on the left-hand side will show the input and output channels and allow sample rate and word length to be set. Sample rates up to 192 kHz can be selected:

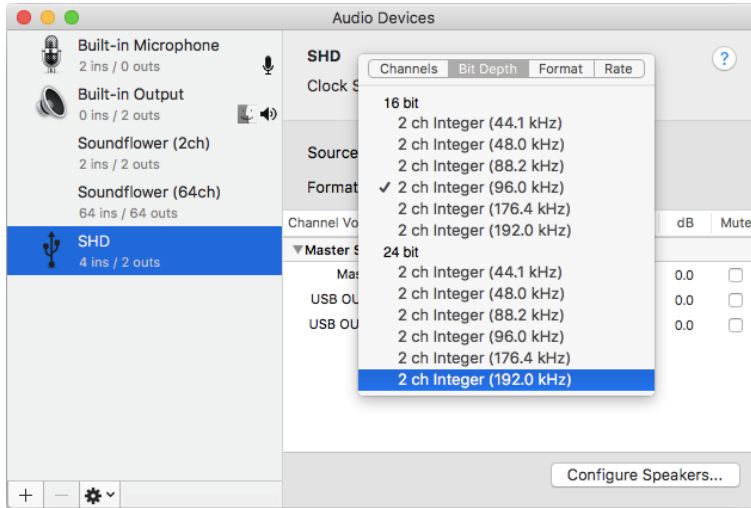

To set the SHD Series processor as the default audio output device, right-click and select “Use this device for sound output”. Individual audio playback programs may allow the processor to be selected for audio output independently of the system default.

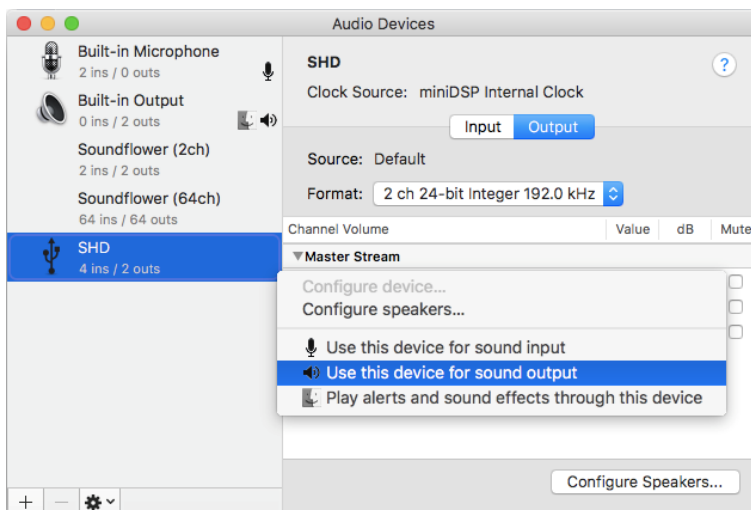

The SHD also supports four channels of output to the computer, which can be seen by clicking on the **Input** button shown in these screenshots. These four channels are the same signal as the four output channels. They can be used to monitor or record the outputs of the SHD.

5.3.2 Windows

Note: playing USB audio from Windows requires that the UAC driver package be installed first (page 34).

5.3.2.1 Windows default audio device

To set the SHD Series processor as the default audio output device, open the Windows Control Panel and navigate to the Audio Devices section. On the Playback tab, select the device named “SHD Series” and click on the “Set Default” button.

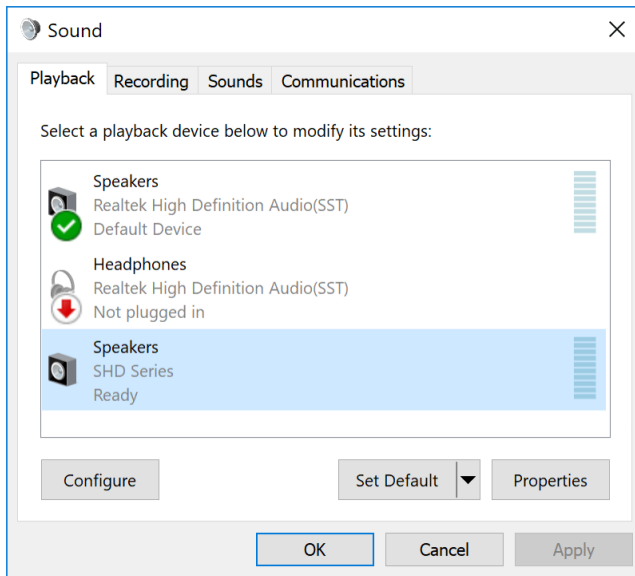

To change the bit depth and sample rate, click on the Properties button and select the Advanced tab. Drop down the selection menu, choose the desired value and click OK. Sample rates up to 192 kHz can be selected:

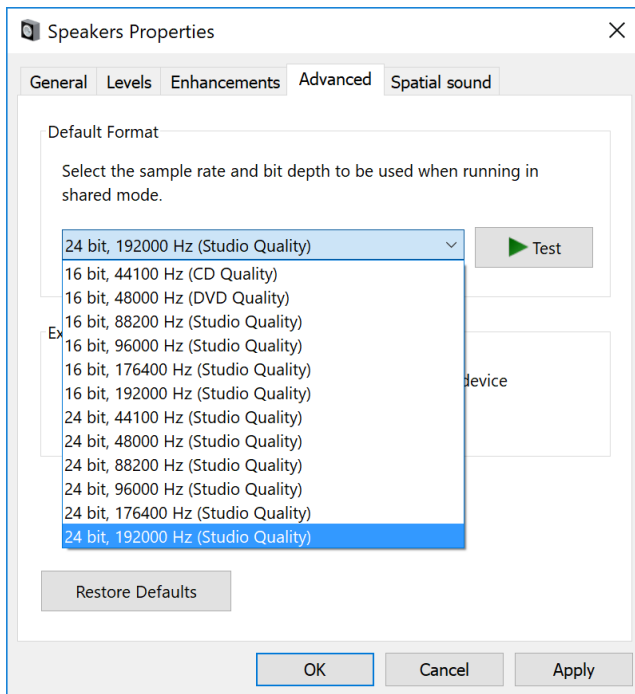

The SHD Series processor also sends its four output channels to the computer. These can be used to monitor or record the output channels from the SHD. To select The SHD Series processor as the default input device, go to the Recording tab, select SHD Series and click the Set Default button:

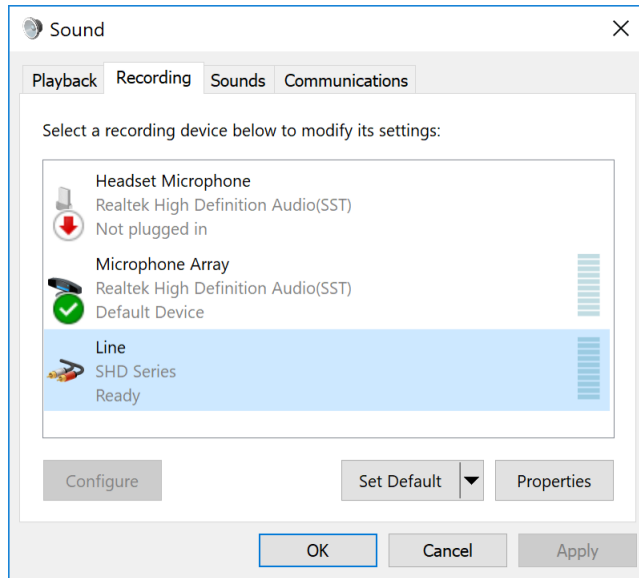

5.3.2.2 ASIO

If your audio application program supports ASIO audio drivers, we recommend selecting the miniDSP ASIO Driver in the settings of that program. This typically allows the program to automatically change sample rate. For example, in JRiver Media Center:

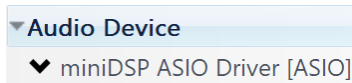

5.3.2.3 miniDSP UAC control panel

The current settings of the SHD Series processor can be viewed by opening the miniDSP UAC Control Panel from the Windows Start menu. This control panel allows you to view current settings. In addition, it can be used to set buffer size, although we recommend that you leave this setting at the default. If you are having an issue with inadequate output volume over USB playback, check the Volume tab.

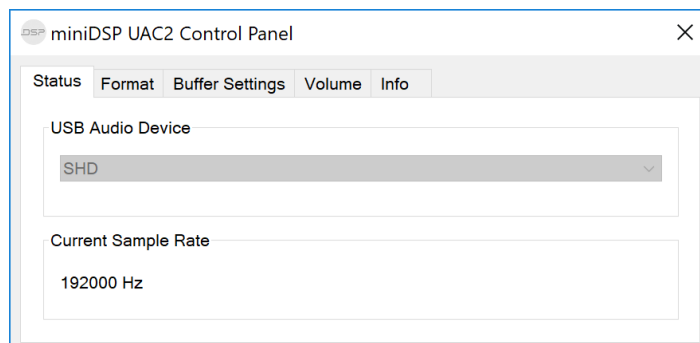

5.4 NETWORK AUDIO

For streaming network audio, the miniDSP SHD Series processors ship with a custom version of the popular network endpoint [Volumio](#), running on its own Linux processor board within the processor chassis. Volumio has a wealth of functions for controlling and delivering network audio at sample rates up to 192 kHz.

This section will provide a few pointers to get you started.

Please note however that since Volumio and the other software mentioned in this chapter is third-party software, miniDSP support for this software is *limited*. We recommend using the support resources for each software package.



If you are knowledgeable with Linux, you will find that you can log into the SHD's Volumio installation using ssh. Please note however that alterations to the system or installation of additional software outside of the Volumio web interface is **outside of the scope of miniDSP support**.

5.4.1 Getting connected

Connect an Ethernet cable from your home network router to the Ethernet port on the rear panel.

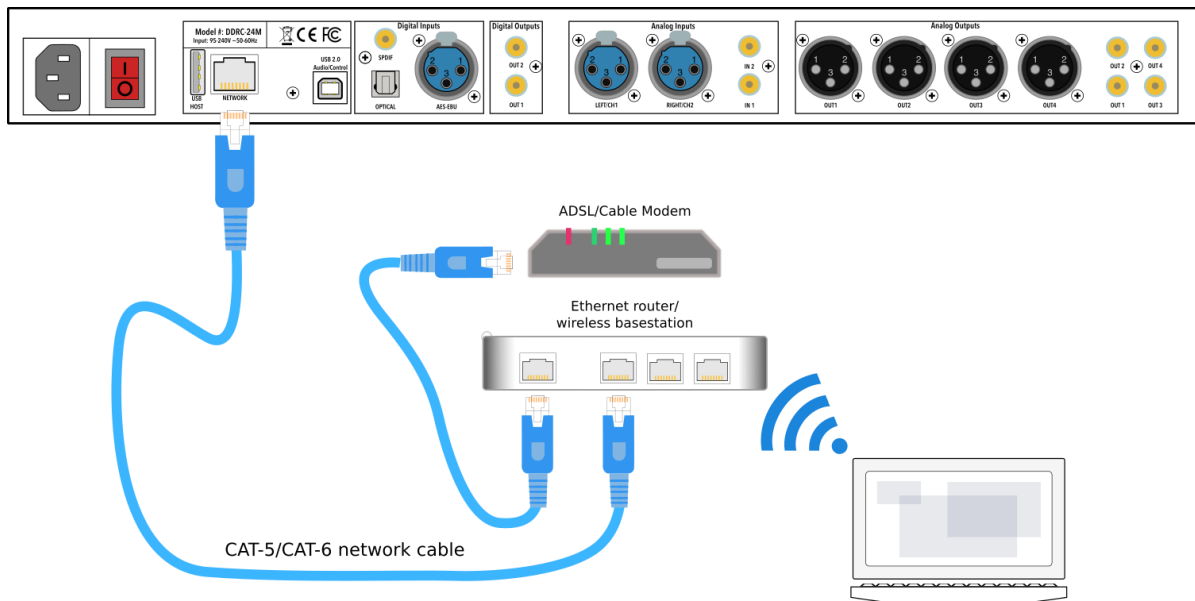

A short Ethernet cable is provided with the unit. If a longer cable is required, these are readily available from computer stores and online. The recommended maximum length for Ethernet cables is 100 meters (330 feet).

Note that your router must be set to allow dynamic IP addresses i.e. DHCP. Most routers will have this function enabled by default.

Note: Wi-Fi connection is not supported. Please use a hard-wired Ethernet connection.



5.4.2 Web interface

To open the web interface, enter one of the following in your web browser window (or click on the links embedded in this document):

- <http://minidsp-shd>
- <http://minidsp-shd.local>

Depending on your network hardware, one may work while the other will not. Create a bookmark in your browser for the link that brings up the web interface.

When you connect to the interface for the first time, you will enter a simple setup wizard. Just proceed through the steps:

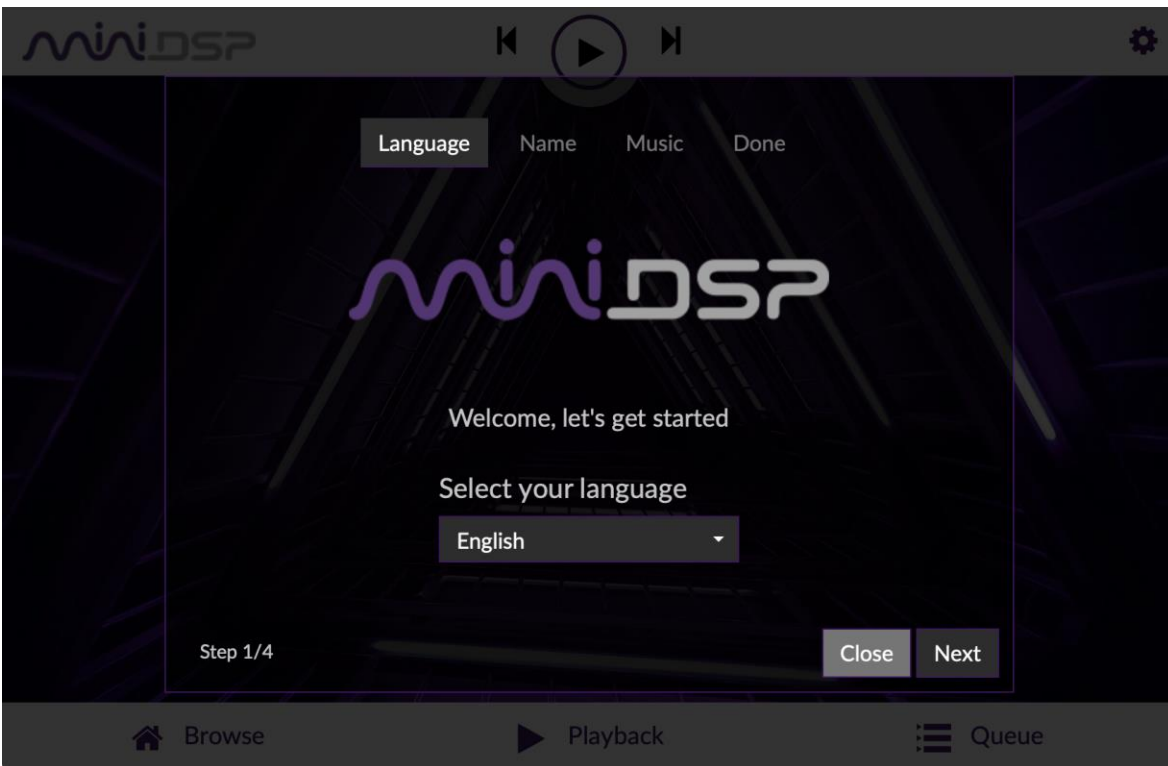

Use the front panel encoder or the remote control to select the LAN input source:

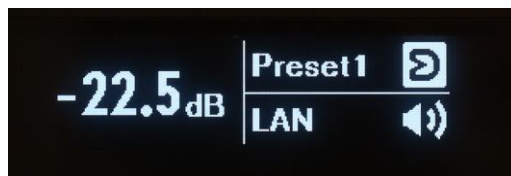

5.4.3 Playing from USB stick

Insert a USB stick containing music files into the USB HOST port on the rear panel, next to the Ethernet port.

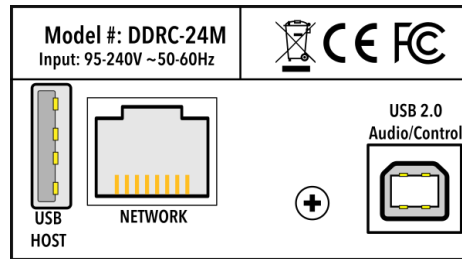

Volumio will start indexing the USB stick. Click on the Browse tab at the lower left:

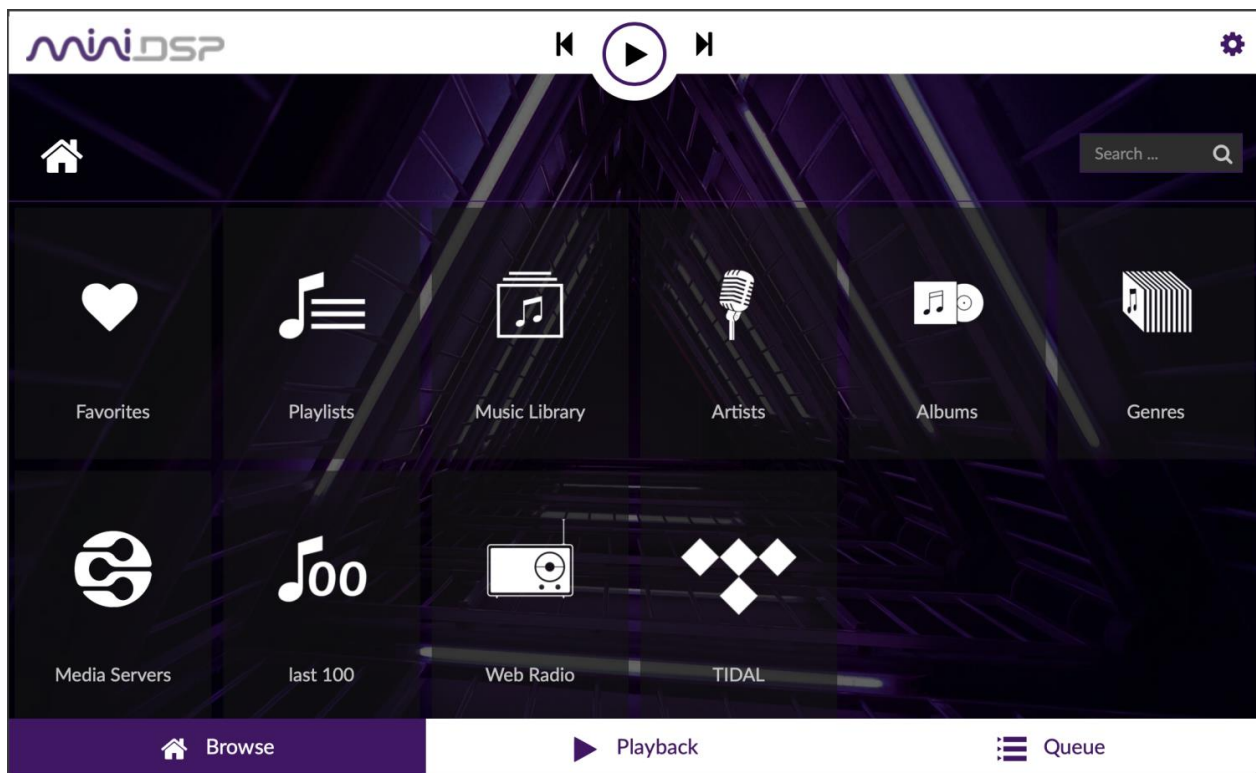

You can either browse the stick directly by going to “Music Library,” or view by artists or albums. Click on an album artwork and then press the Play button (triangular icon).

5.4.4 TIDAL and Qobuz

TIDAL is a streaming service for lossless CD-quality and high-resolution audio. It is currently available in 53 countries. For more information on availability, see the Tidal article "[TIDAL – where we're available.](#)"

[Qobuz](#) is a streaming service for lossless CD-quality and high-resolution music. It is currently available in 11 countries in Europe, with launch in the United States expected in late 2018. For more information on availability, see the Qobuz article "[Where is Qobuz available?](#)"

Both of these services are supported by the miniDSP SHD. You do not need a special Volumio subscription to access these services. You will, however, need to have an account with your choice of streaming provider.

To enable your chosen streaming service, simply drop down the **My Music** menu in the Volumio web interface and scroll down to the Streaming Services section. Enter your username and password for either TIDAL or Qobuz and click Login. Et voila! If successful, you can go to the **Browse** tab and select the streaming service to browse for music to play.

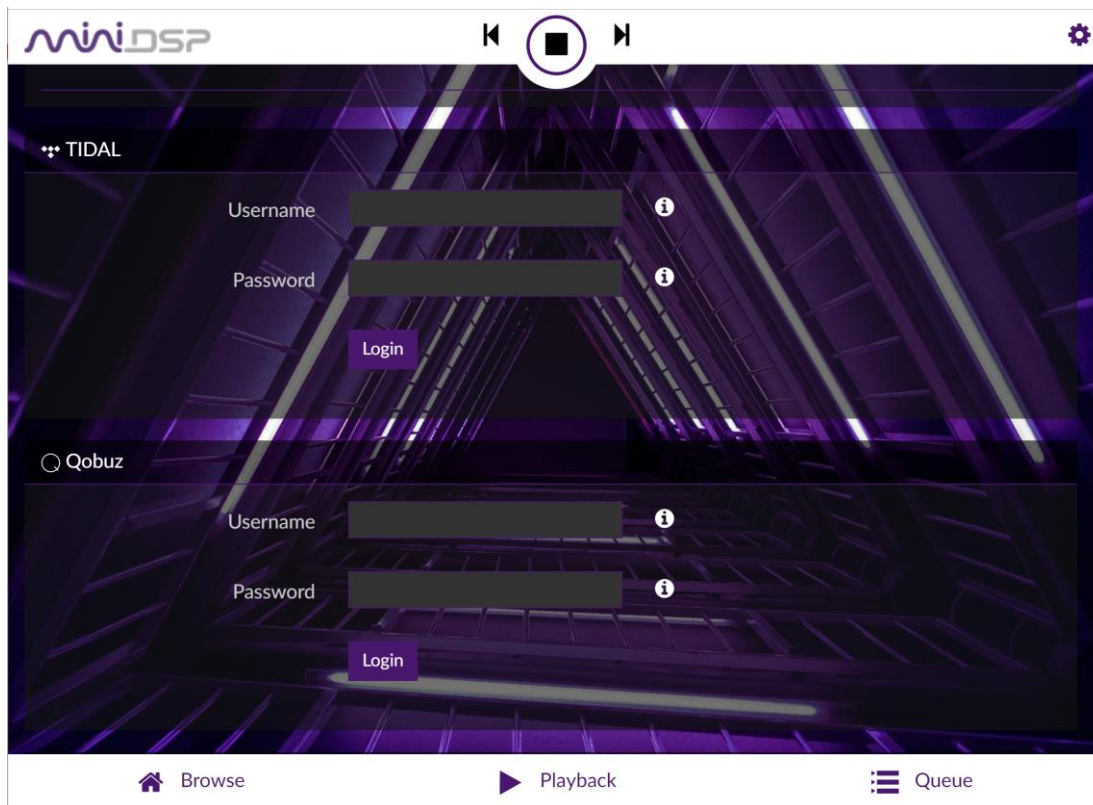

5.4.5 Spotify streaming

The web interface can be used to stream from Spotify. This requires a Spotify premium account, which you must first obtain on the [Spotify website](https://www.spotify.com). Once you have that, click on the gear icon in Volumio (top right) and go to the Plugins menu. Locate the Spotify plugin and click Install.

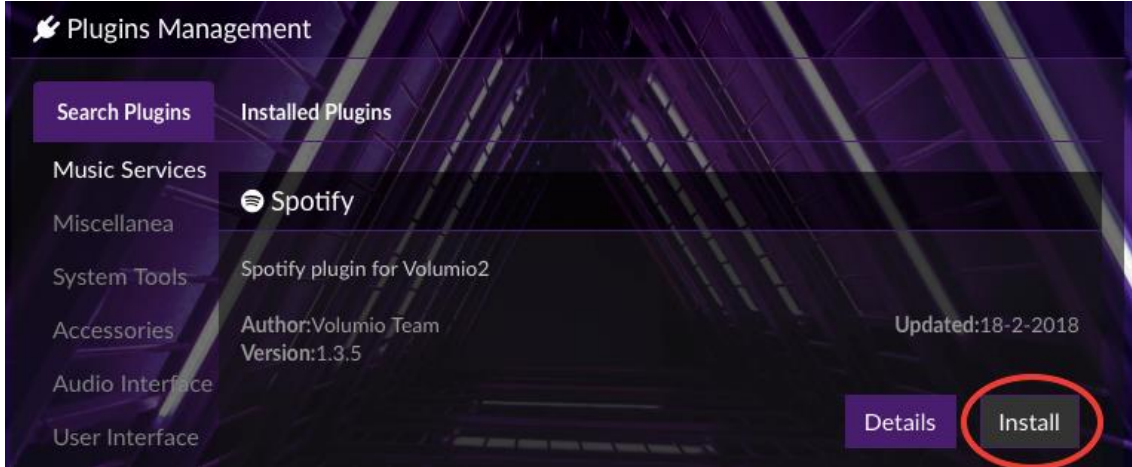

Once installation is complete. Go to the Installed Plugins tab and click on Spotify. Click on the On/Off button to enable it, then click Settings, where you will be able to enter your Spotify username and password.

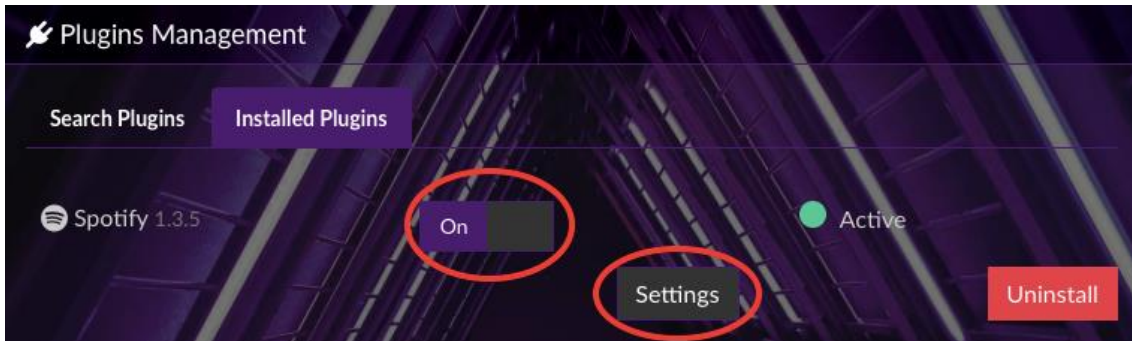

Click on Browse at the lower left. You should see the Spotify icon:

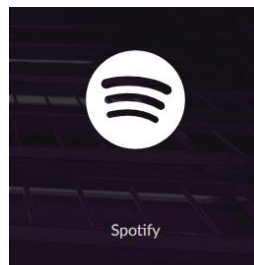

Click on the Spotify icon and use it to browse or search the Spotify library.

5.4.6 Using multiple SHD Series processors

It's easy to have more than one SHD Series processor on the same network and control them independently. On the first SHD Series processor, drop down the menu from the gear icon at the top right and select "System." Set the Player Name, like this:

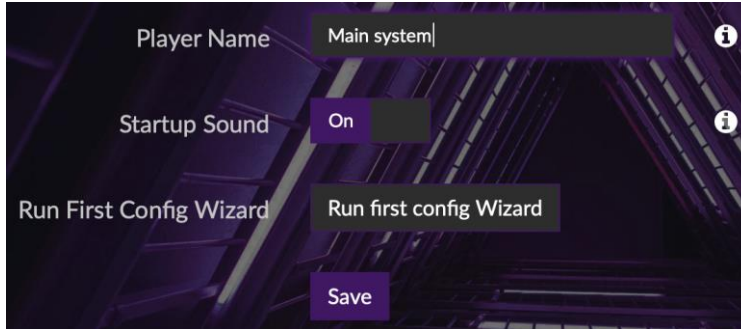

Drop down the gear icon and select Shutdown, then click Restart.

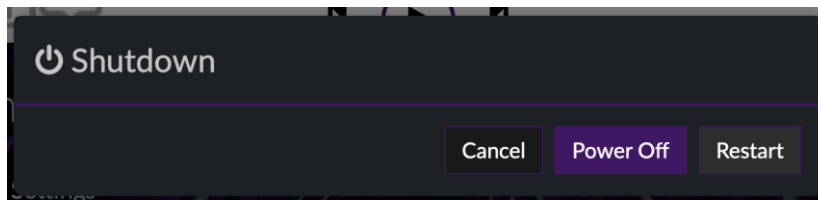

Then connect and turn on the second SHD Series processor. Connect to it at <http://minidsp-shd.local>, and change its name away from the default. Then reboot it.

To connect, you will need to use the new player name. You can use either name. If you used spaces in the name, replace the spaces with hyphens. For example, with our system we connected to <http://main-system.local>. Click on the Playback tab, and both SHD Series processors will appear in the lower section of the screen. Click on each to control them independently.

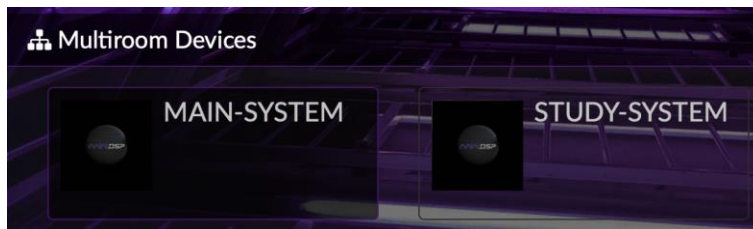

Note: clicking on the name of each processor gives you independent control of them. Currently, synchronized playback to multiple SHD Series processors is not supported.

6 SOFTWARE INSTALLATION

SHD Series processors are configured by software running on a PC or Mac.

6.1 DOWNLOAD THE SOFTWARE

If you purchased your product directly from miniDSP, your software will be available from the [User Downloads](#) section of the miniDSP website when your order ships. To access the download, you will need to be logged into the website with the account you created when purchasing.

If you purchased your product from a miniDSP dealer, you will receive a coupon together with the product. Redeem this coupon and select the Plugin Group “Dirac Series” at the link below:

- <https://www.minidsp.com/support/redeem-coupon>

The User Downloads link is visible from the dropdown menu at the top right of the website page:

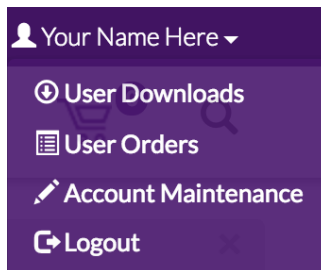

Navigate to the **SHD Series** section. There you will find a single download containing all software. Download this file and unzip it (on Windows, right-click and select “Extract All...”; on Mac, double-click). The unzipped download has a name like **SHD_v1_6_fw_v1_8** and will contain the following folders:

Dirac Live

This folder contains the installers for **Dirac Live Calibration Tool for miniDSP (DLCT)** stereo version, which is used to perform the Dirac Live calibration, including taking measurements, generating correction filters, and loading them into the processor. There are separate Windows and Mac versions.

Plugins

This folder contains the installers for the **SHD plugin**, used to set up non-Dirac signal processing, configure remote control codes and perform various other maintenance operations on the processor. There are separate Windows and Mac versions.

WinDrivers

This folder contains the installers for the drivers that must be installed on Windows so DLCT and the SHD plugin can communicate with the processor. It also enables USB audio streaming from the computer. *To use the SHD Series processors with Windows, this driver **must** be installed.*

XMOS_Firmware

This folder contains the firmware for the processor and the Windows and Mac programs that will update the firmware. See Firmware Upgrade starting on page 81 for the procedure.

6.2 SOFTWARE INSTALLATION — WINDOWS

Possible Windows installation issues

The miniDSP software requires that a number of other frameworks be installed for it to work. For Windows 7 and later, these packages should be installed automatically. For earlier versions of Windows, please download and install the following frameworks before attempting to install any miniDSP software. You can also manually install these if you receive an error message that required software is missing.

- [Microsoft .NET framework](#) (version 3.5 or later)
- Latest version of [Adobe Air](#)
- Microsoft Visual C++ 2010 Redistributable Package: for [x86](#) (32-bit operating system) or [x64](#) (64-bit operating system).

SHD plugin installation

1. Navigate to the **Plugins** folder of the software download and then to the **Windows** folder.
2. Double-click on the **SHD.exe** installer program to run it. We recommend that you accept the default installation settings.

Dirac Live Calibration Tool (DLCT) installation

1. Navigate to the **Dirac Live** folder of the software download and then to the **Windows** folder.
2. Double-click on the installer to run it. The installer will have a name similar to **Dirac Live Calibration Tool v1.2.33.8780 Setup.exe** (the version number starting with v1.2... may be different). We recommend that you accept the default installation settings. However, on the last screen, uncheck the box to start Dirac Live automatically (you will need to install the driver as described on the next page before using DLCT).

Completing Dirac Live Calibration Tool Setup

Dirac Live Calibration Tool has been installed on your computer.

Click Finish to close Setup.

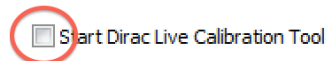

UAC driver installation

1. Connect the processor to the computer using the supplied USB cable, and power it on.
2. Navigate to the **WinDrivers** folder of the software download and double-click on the appropriate installer:
 - **miniDSP_UAC2_v2.29.3_ForWinXP_Vista.exe** for Windows XP and Vista
 - **miniDSP_UAC2_v4.47.0_ForWin7_8_10.exe** for Windows 7, 8, and 10

(The version number embedded in the filename may be different.)

We recommend accepting the default installation location. Once the driver installation completes, click the **Finish** button.



The Windows PC will not be able to communicate properly with the processor if it was not connected by USB and powered on when you installed the driver. If that is the case, you will need to uninstall the driver, connect the processor, power it on, and run the installer again.

Note: the first time run DLCT, you may see a warning from Windows Firewall as shown below. If so, ensure that “Private networks...” is checked and “Public networks...” is not checked. Then click on “Allow access.”

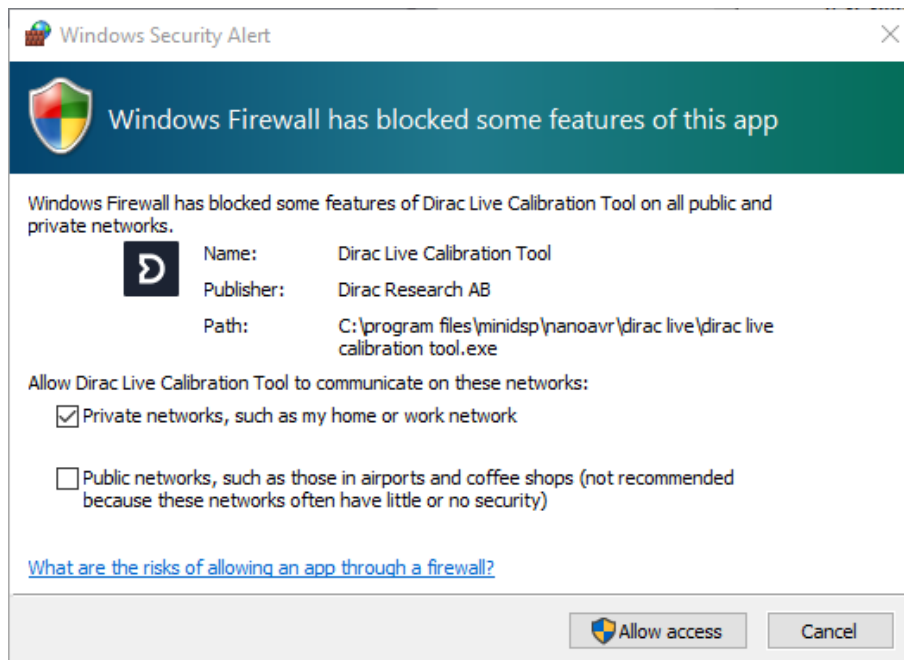

6.3 SOFTWARE INSTALLATION — MACOS / OS X

Possible Mac installation issues

If double-clicking on an installer brings up a message that the installer cannot run, use this alternate method:

1. Right-click on the installer (or click while holding the Control key).
2. Move the mouse over the “Open With” item and then click on “Installer (default).”

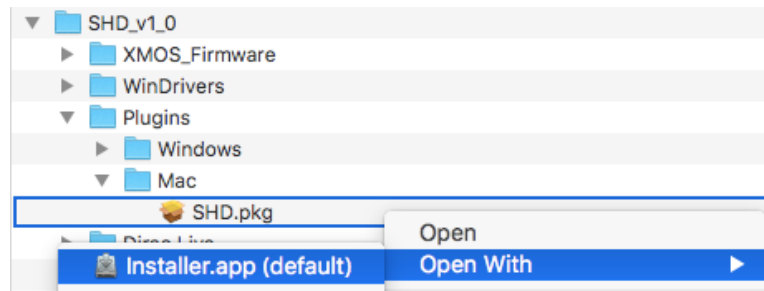

3. The following window will appear. Click on “Open.”

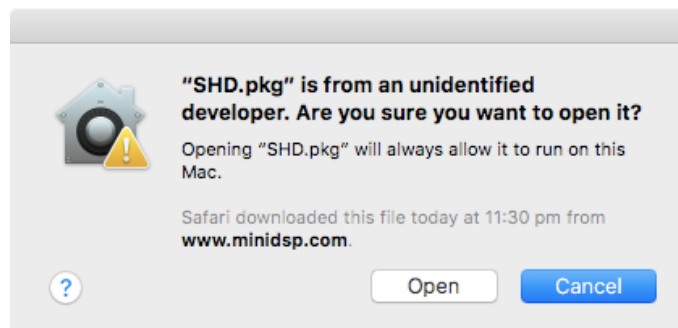

SHD plugin installation

1. Navigate to the **Plugins** folder of the software download and then to the **Mac** folder.
2. The installer program is named **SHD.pkg**. To run it, double-click on it, or right-click and open as described above. We recommend that you accept the default installation settings.
3. To run the SHD plugin, locate **SHD.app** in the Applications -> miniDSP folder and double-click on it. To make it easier to run in future, right-click on its dock icon and select Options -> Keep in Dock.

Dirac Live Calibration Tool (DLCT) installation

1. Navigate to the **Dirac Live** folder of the software download and then to the **Mac** folder.
2. The installer program will have a name similar to **Dirac Live Calibration Tool v1.2.33.8780.pkg** (the version number starting with v1.2... may be different). To run it, double-click on it, or right-click and open as described above. We recommend that you accept the default installation settings.
3. To run DLCT, locate **Dirac Live Calibration Tool.app** in the Applications -> miniDSP folder and double-click on it. To make it easier to run in future, right-click on its dock icon and select Options -> Keep in Dock.

7 ACOUSTIC MEASUREMENT FOR DIRAC LIVE

The **Dirac Live Calibration Tool Stereo** (DLCT) needs a set of measurements made in your listening room so that it can calculate the room correction filters. You will make these measurements using the SHD Series processor, your computer, and a miniDSP UMIK-1 measurement microphone.

7.1 LOUDSPEAKER AND MICROPHONE POSITIONING

Prior to performing acoustic measurements, optimize your loudspeaker and listening positions. Start with the recommendations of the manufacturer of your loudspeakers. Loudspeakers designed for home hifi use typically perform best away from the walls, whereas speakers designed for studio use may be designed for use closer to walls or other surfaces. With Dirac Live®, you have more freedom with loudspeaker placement, but the best result will still be achieved if optimal loudspeaker placement is used together with Dirac Live®.

You should also experiment with toe-in – many loudspeakers benefit from pointing directly at the listening position or even slightly in front. The listening position should be away from the rear wall, as placing the listening chair or sofa right against the wall will result in increased early reflections and changes in timbre.

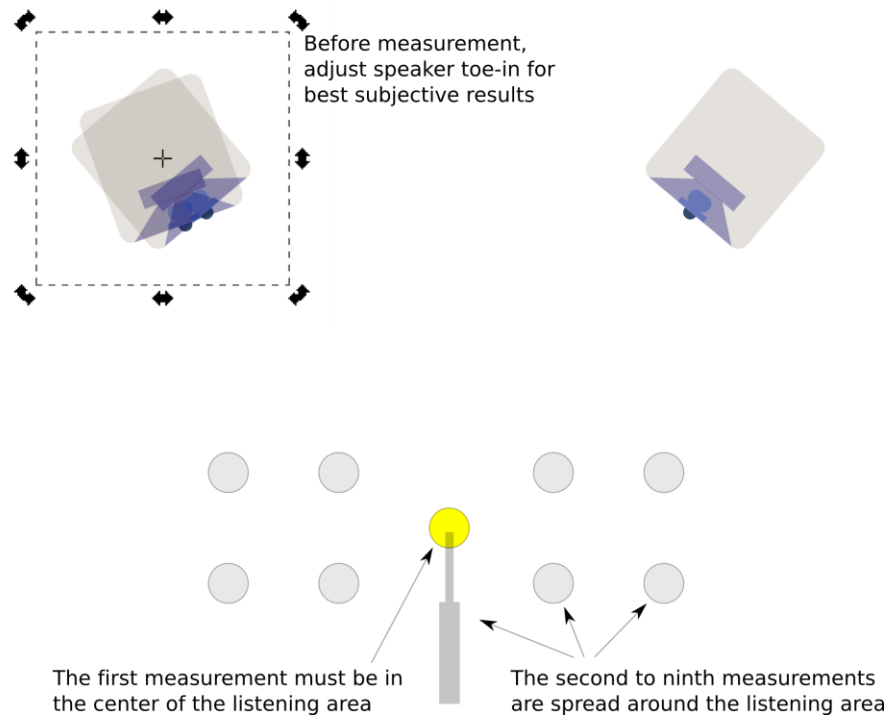

A total of nine measurements must be taken, with the microphone located in different positions in the room and pointed between the two speakers. The first measurement must be taken at the central location of the listening area, as this location sets the levels and delays of each speaker. While this location will usually be an equal distance from both speakers, Dirac Live® will adjust in cases where it is not. Eight more measurements are then taken at locations spread around the listening area and at different heights from the floor.

7.2 PREPARING FOR ACOUSTIC MEASUREMENT

The figure below shows a typical connection diagram for performing acoustic measurement. No changes to existing audio connections are needed. Simply:

1. Connect the supplied USB (type A to type B) cable from the processor to a USB port on the computer.
2. Connect the supplied USB (type A to mini type B) cable from the UMIK-1 to a USB port on the computer.

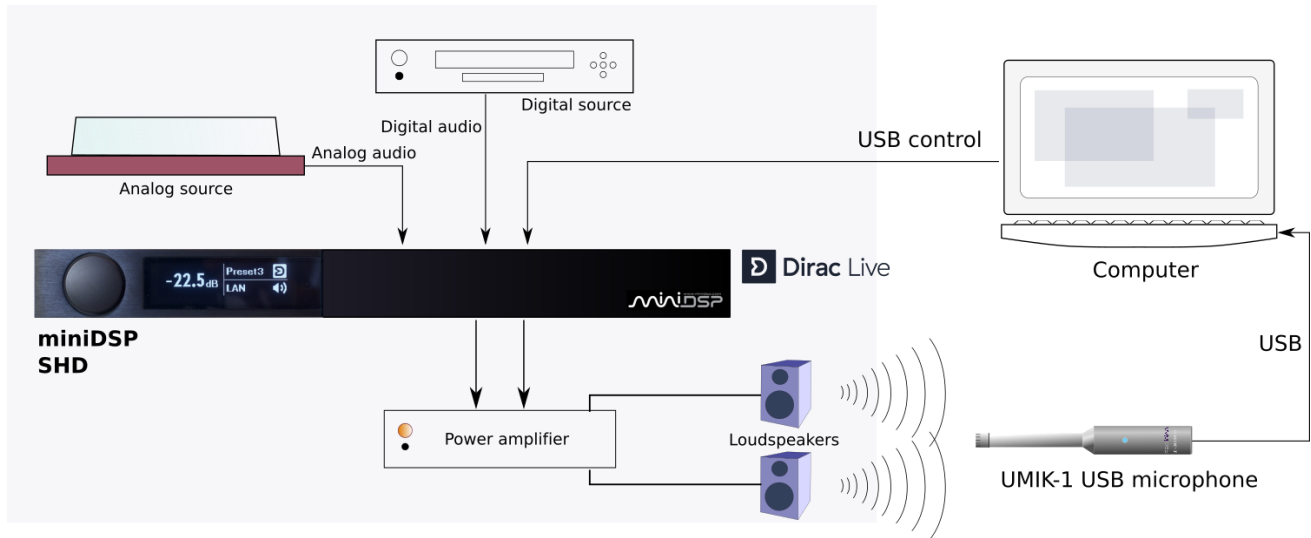

Place the UMIK-1 microphone into a microphone stand and position the computer and cabling so that there is enough freedom of movement to move the microphone into the needed locations. A small tripod stand is supplied with the UMIK-1, but a larger stand with boom arm can be used if desired. If necessary, a USB extension (up to a total USB cable length of 5 meters) can be used. In larger spaces, an active USB repeater may be needed.



Download the unique calibration file for your UMIK-1 from the [UMIK-1 page](#) by entering your microphone's serial number. It is in the form xxx-yyyy and labelled on the microphone. Two calibration files are provided, one for when you point the microphone at or between the speakers, and a "90-degree" file for when pointing the microphone at the ceiling. For stereo systems, we generally recommend pointing the microphone between the two speakers.

7.3 CONFIGURING FOR MEASUREMENT

Start Dirac Live Calibration Tool for miniDSP (DLCT).



Be sure to quit the **SHD plugin** program before starting DLCT. Running the two programs at the same time will result in communication conflicts and odd behavior.



The main areas of the interface are:

Logo and status progress bar

This area shows a progress bar with current status when the program is performing calculations.

Selection tabs

Each tab selects a different step of the calibration process. These are generally worked through in order, from top to bottom. This section covers the first four tabs; the final two are covered in [Dirac Live Filter Design and Download](#).

Load and save a project

Projects can be saved to a file and reloaded at a later time. See [Saving and loading projects](#).

Back to previous / proceed to next

Use these two buttons to advance to the next tab when each is complete, or to go back to the previous tab to make alterations. The tabs at the left can also be clicked on directly.

Help open/close

Click on the small Help divider at the right of the window to open a pane with help on the currently selected tab. Click on the divider again to close the help pane.

7.3.1 Check your configuration/preset (advanced)

When you run a measurement for Dirac Live calibration, the Dirac Live test signal passes through the Routing matrix and the output channel processing. Therefore, it is important that you have the correct configuration before running the calibration measurement.

For example, suppose you have set up your routing and output channels for a subwoofer crossover in configuration 2. Before starting Dirac Live calibration, double-check that the processor is set to configuration 2.

7.3.2 Sound System tab

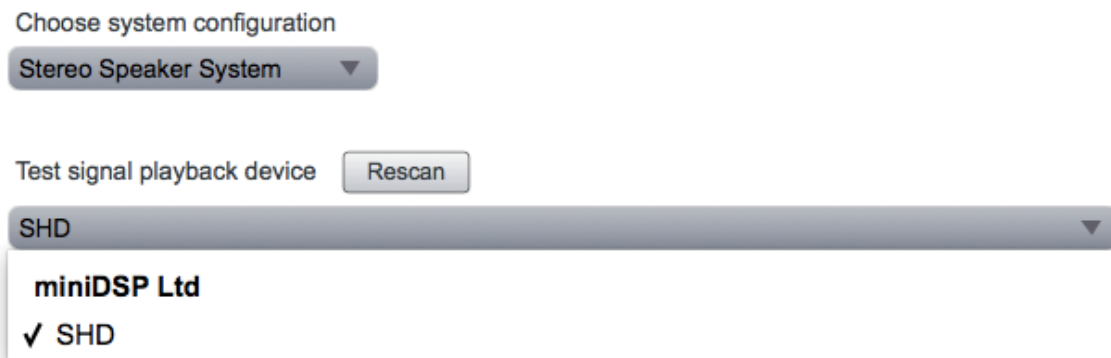

The **Sound System** tab is preset for you, provided that you have your SHD Series processor connected to the computer via USB.

Choose system configuration

Preset to **Stereo Speaker System**. This is the only configuration supported by the SHD Series processors.

Test signal playback device

Preset to **SHD**. If this is not present, check that your processor is connected via USB and powered on, then click the **Rescan** button.

Once you have verified that this tab is correct, click the **Proceed** button.

7.3.3 Mic Config tab

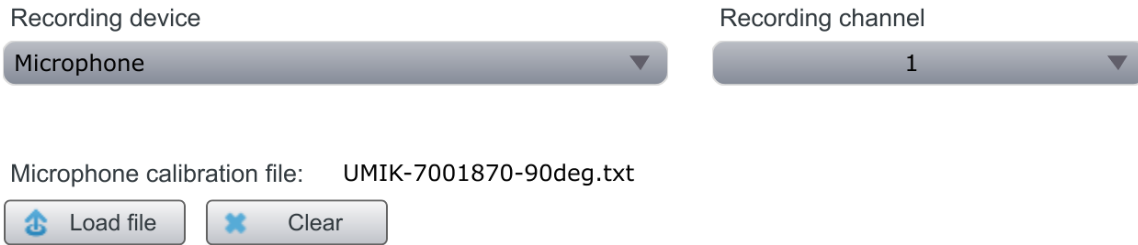

On the **Mic Config** tab, set the following parameters.

Recording device

Preset to the UMIK-1. Depending on your platform, this may say “UMIK-1. Gain: 18 dB” instead of “Microphone.” You can use the drop-down menu to confirm that the device is the UMIK-1:



If no recording device is selected, check that the UMIK-1 is connected securely to the computer via its USB cable, then go back to the **Sound System** tab and click on **Rescan**. Then come back to this tab, drop down the selection menu and select “Microphone” underneath UMIK-1.



The miniDSP version of DLCT will only recognize the miniDSP UMIK-1. Other microphones or audio interfaces can not be used.

Recording channel

Select **1** from the drop-down menu.

Microphone calibration file

Each UMIK-1 measurement microphone is individually calibrated to ensure accuracy. To download the unique calibration file for your microphone, go to the [UMIK-1 page](#) and enter your microphone's serial number. It is in the form xxx-yyyy and labelled on the microphone.

Then click on the **Load File** button and select the regular or “on axis” calibration file. Usually, it will be saved to the computer with a name that is the same as the serial number e.g. “7001870.txt”. (Do not use the calibration file with “_90deg” in the name e.g. “7001870_90deg.txt” unless you are pointing the microphone at the ceiling.)

Once you have verified that this tab is correct, click the **Proceed** button.

7.3.4 Output & Levels tab

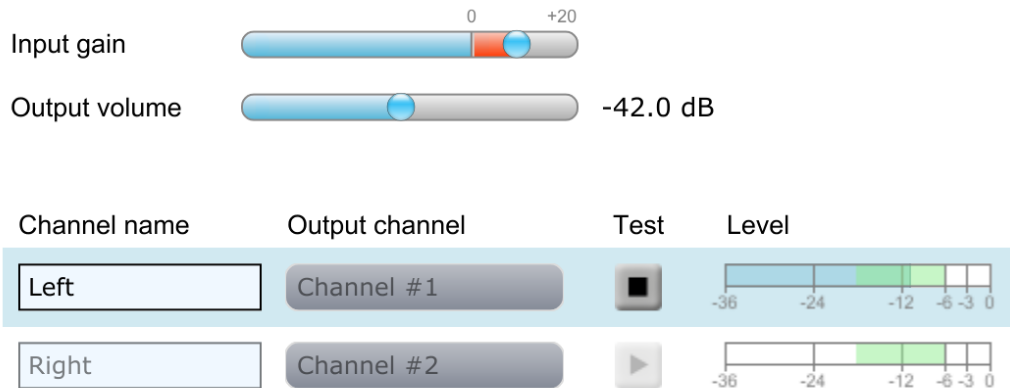

The **Output & Levels** tab is used to set the signal level used in subsequent measurements. We recommend following this procedure:

1. Set the **Output volume** slider all the way down, at -80 dB.
2. Click on the **Test** button for the left channel and gradually increase the **Output volume** slider. You should hear pink noise playing from the left speaker. Continue to increase volume until it is at a moderate level, such that your voice would have to be raised to converse with someone sitting next to you.
3. Increase the **Input gain** slider so that the blue bar on the level meter is about in the middle of the green section, or around -12 dB (as shown in the screenshot above).
4. Click again on the **Test** button for the left channel to stop the test signal.
5. Click on the **Test** button for the right channel and confirm that the level is reasonably close to -12 dB. If necessary, adjust **Input gain** or **Output volume** so that both channels are in the green.

When done, click the **Proceed** button.

7.4 RUNNING THE MEASUREMENTS

Measurements are performed on the **Measurements** tab.

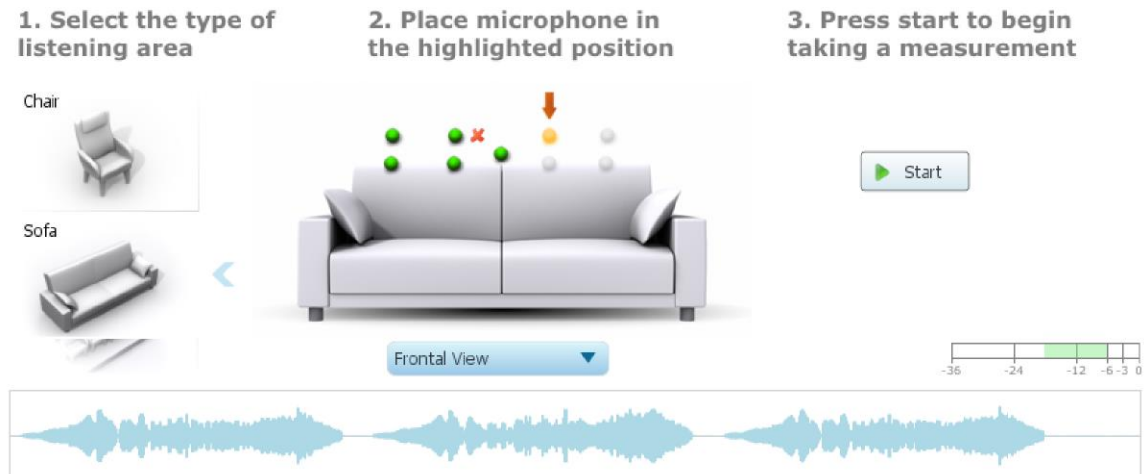

Measurements should be performed under good conditions. While the measurement technique used by Dirac Live is quite robust, low-frequency noise (traffic, machinery, aircraft, storms) in particular can adversely affect measurement accuracy. A high level of ambient noise can degrade signal to noise ratio and prevent the algorithm from analyzing the test sweep signal properly. Minimize the effect of any external noise, ensure that measurement signal levels are adequate, and/or choose a suitable time for performing measurements.

7.4.1 Listening environment

DLCT presents two different listening environments as a visual guide to positioning the microphone for each measurement: **Chair**, for a single listening seat, and **Sofa**, for multiple listening seats. Select a listening environment by clicking on the chosen icon.

The pictorial representation of the selected listening environment has a set of dots marking the microphone locations. Completed measurements are green, while the next measurement to be done is yellow and has a red arrow marker pointing to it. A drop-down menu underneath selects three different views, which should be used to help you place the microphone in the correct location.

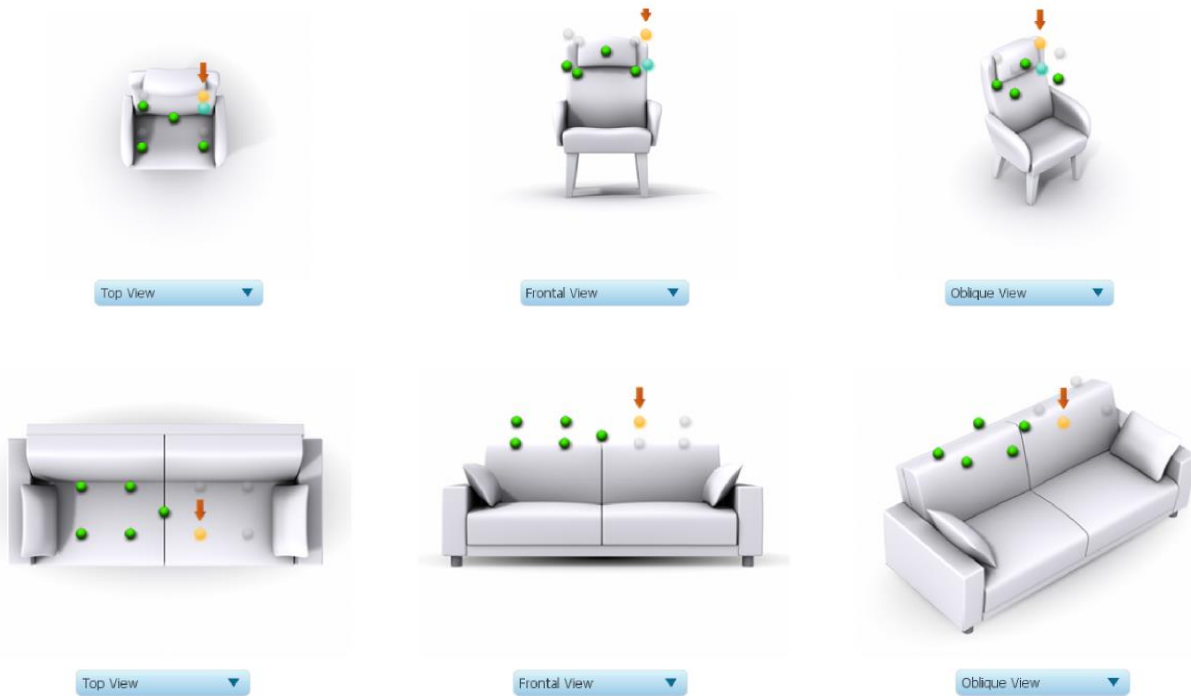

While the visual guide indicates a suitable set of microphone locations, these locations can be varied to suit individual circumstances. It is, however, imperative that the first measurement is taken in the center of the listening area, as this measurement is used to set the levels and delays of each channel. The subsequent eight measurements should be well spread out over the entire listening area so that Dirac Live can acquire a good set of measurements that capture the acoustic behavior of the room. Placing all microphone locations too close to each other may result in “over-correction” that will sound dry and dull.

For example, if using the **Chair** listening area, spread the microphone positions over a circle with a diameter of at least a meter (three feet) and vary the microphone height from the central position by at least 30 cm (one foot) up and down. If using the **Sofa** listening environment, spread the measurement locations over the full listening area and vary the height up and down by at least 30 cm (one foot).

A different set of locations other than those indicated by the visual guide and the above guidelines can be used if necessary. The important thing is to ensure that the measurement locations are spread out over the whole listening area and that the microphone is moved a sufficient distance vertically as well as horizontally.

In some cases, such as when the listening area is very close to the loudspeakers or the loudspeakers have a very narrow dispersion pattern, the size and in particular the height of the measurement area can be reduced, to avoid discrepancies caused by varying output response from the speakers themselves.

7.4.2 Executing measurements

With the microphone in place at the central location and pointed between the two speakers, click on the **Start** button. The processor will generate a test signal, audible as a frequency sweep through the left speaker, then the right, and then the left again. While the measurement proceeds, the time-domain graph of the captured audio signal is displayed at the bottom of the measurement tab. (This graph is related to the magnitude response but is not the same display. Its purpose is to verify that the recorded signal level is in a suitable range.)

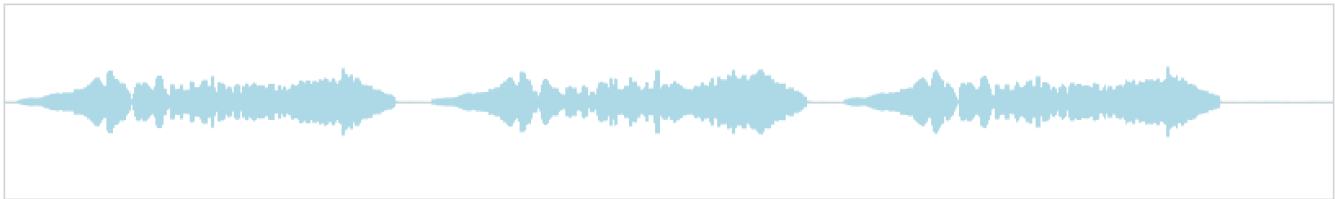

At the completion of the measurement, the status bar will update with a progress indicator as the program performs calculations on the measurement. If the measurement was successfully captured, the red arrow marker will advance to the next location to be measured. If the program indicates that the measurement was not successful, you will need to take corrective action. The most common error is related to signal level:

- The measurement signal is too low to ensure a clean capture.
- The measurement signal is too high, and the audio signal has exceeded the maximum level (clipping). This is shown in red on the signal graph.

In either of the above cases, go back to the **Output & Levels** tab and adjust **Output volume** or **Input gain**. Then re-run the measurement. (You do not need to redo the measurements you have already successfully completed.)

7.4.3 Viewing and redoing measurements

Click on the green dot for any completed measurement to display its measured time-domain graph.

After clicking on a green dot, a small red “X” will appear next it. Click on the “X” to delete the measurement. The status bar will indicate that the program is recalculating parameters.

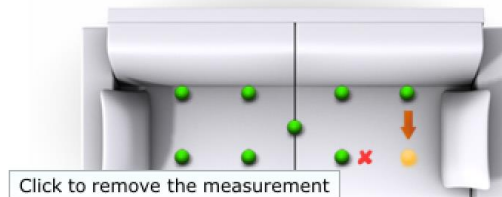

To redo a measurement, delete it, move the microphone to the appropriate location, and click on **Start**. Note: if more than one measurement is deleted, the marker will move to the lowest-numbered one.

7.4.4 Completing the measurements

After each successful measurement, the location marker (red arrow) will advance to the next location. Move the microphone to that location, using the three views (top, front, oblique) as a guide to positioning it in the correct location. Then click on **Start** again. Repeat this process until all nine locations have been successfully measured.

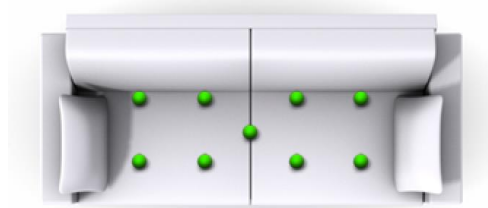

Note that it is good practice to save the project periodically while performing measurements (see [Saving and loading projects](#)). Once all nine measurements have been completed, you can advance to the **Filter Design** tab by clicking on the **Proceed** button or directly on the **Filter Design** tab at the left.



It is important that all nine measurements are completed, to ensure best results from the optimization algorithm. Being patient and thorough will pay audible dividends!

7.5 SAVING AND LOADING PROJECTS

Each set of measurements and the associated configuration settings are a single *project*. The project should be saved at regular intervals. This is done by clicking on the **Save** button. The default location for project files is **My Documents\MiniDSP\Projects** (Windows) or **Documents/MiniDSP/Projects** (Mac).

A project can be reloaded at any time by clicking on the **Load** button. This enables you to generate new correction filters for different target curves at a later date, or to redo any of the measurements. (Note: if you wish to change from the **Chair** to the **Sofa** listening environment, or vice versa, you will need to start a new project.)

8 DIRAC LIVE FILTER DESIGN AND DOWNLOAD

Once the full set of measurements has successfully been taken, DLCT has the acoustical information it needs about your loudspeakers and listening room to create the correction filters.

8.1 WORKING WITH GRAPHS

The **Filter Design** tab shows a number of plots that can individually be turned on and off with the checkboxes near the top.



Avg. spectrum (before)

The average of the measured magnitude responses. These plots are shown in light blue.

Avg. spectrum (after)

The predicted average magnitude response after correction. These plots are shown in green and can only be viewed after filters have been generated with the **Optimize** button.

Target

The target curve – that is, the desired in-room magnitude response. This curve is user-adjustable, so you can fine-tune it to best suit your speakers, room, and preferences. See [Designing your target curve](#).

To display the impulse response instead of the magnitude response, click on the **Impulse** button at the top left of the display. There are two graphs that can be turned on and off with the checkboxes at the top: the measured impulse response (shown in light blue), and the predicted impulse response after correction (shown in light green).

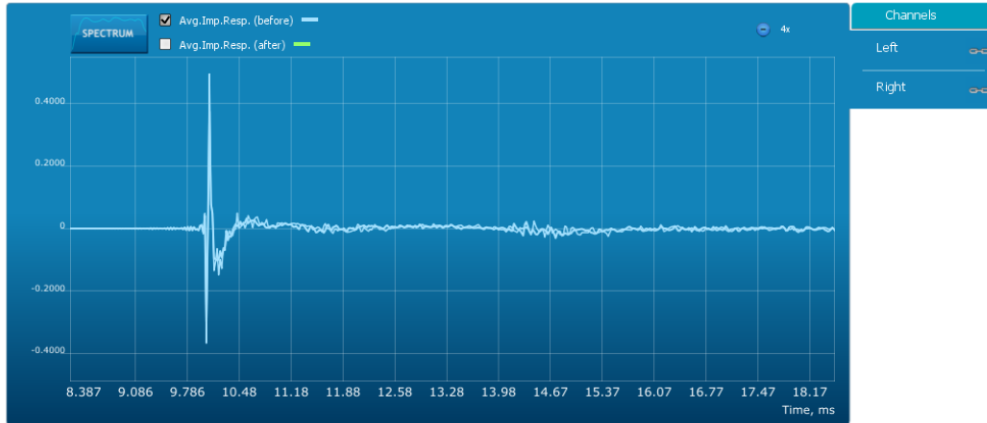

To return to the magnitude response, click on the **Spectrum** button.

The magnitude and impulse response graphs can be viewed at a larger scale. To zoom in and out on the response graphs:

- Drag-select a region of the graph to zoom in on it. (Click the left button, move the mouse while holding the button, release the button.) You can then drag-select a region again to zoom in further.
- Double-click on the graph to zoom back out to the previous zoom level, or click on the small “-” sign next to the zoom indicator at the top right of the display.

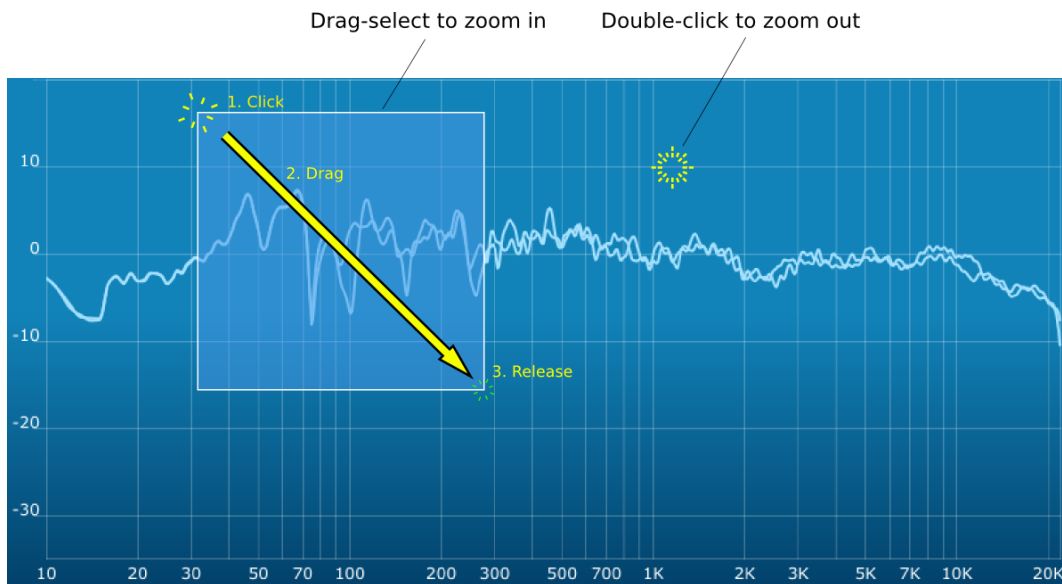
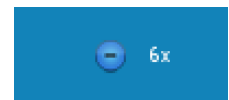

By default, graphs of both left and right channels are shown together. The left and right channels can be unlinked by clicking on the small “chain” icon next to the channel name, at the right of the graphs. Then the graphs of each channel can be viewed separately, by click on the “Left” or “Right” tab. To relink the two channels, drag the “disconnected” channel tab over the top of the selected channel.

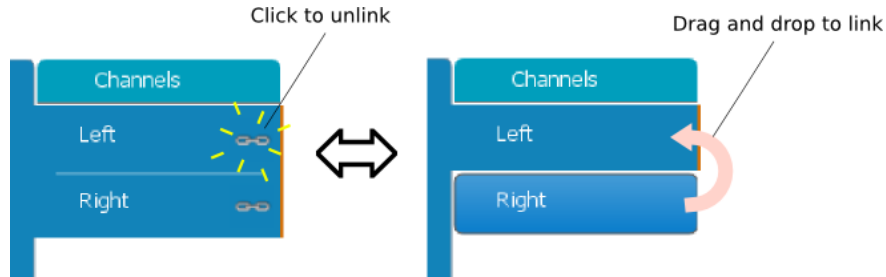

8.2 DESIGNING YOUR TARGET CURVE

The *target curve* is the desired in-room frequency response with the miniDSP SHD Series processor performing digital room correction.

8.2.1 The Auto Target

When first viewing the **Filter Design** tab, an estimated target curve suitable for your speakers is shown as the red curve. This calculated target curve can be restored at any time by clicking on the **Auto Target** button.



Note: restoring the auto target will erase the current target curve. If you wish to keep it, first save it to a file – see [Saving and loading target curves](#).

8.2.2 Editing the target curve

You can edit the target curve to set any desired magnitude response. This is done with the use of *anchor points*, shown as orange dots on the curve:

- Drag an anchor point to move it.
- Double-click on the target curve to add an anchor point.
- Double-click on an anchor point to delete it.

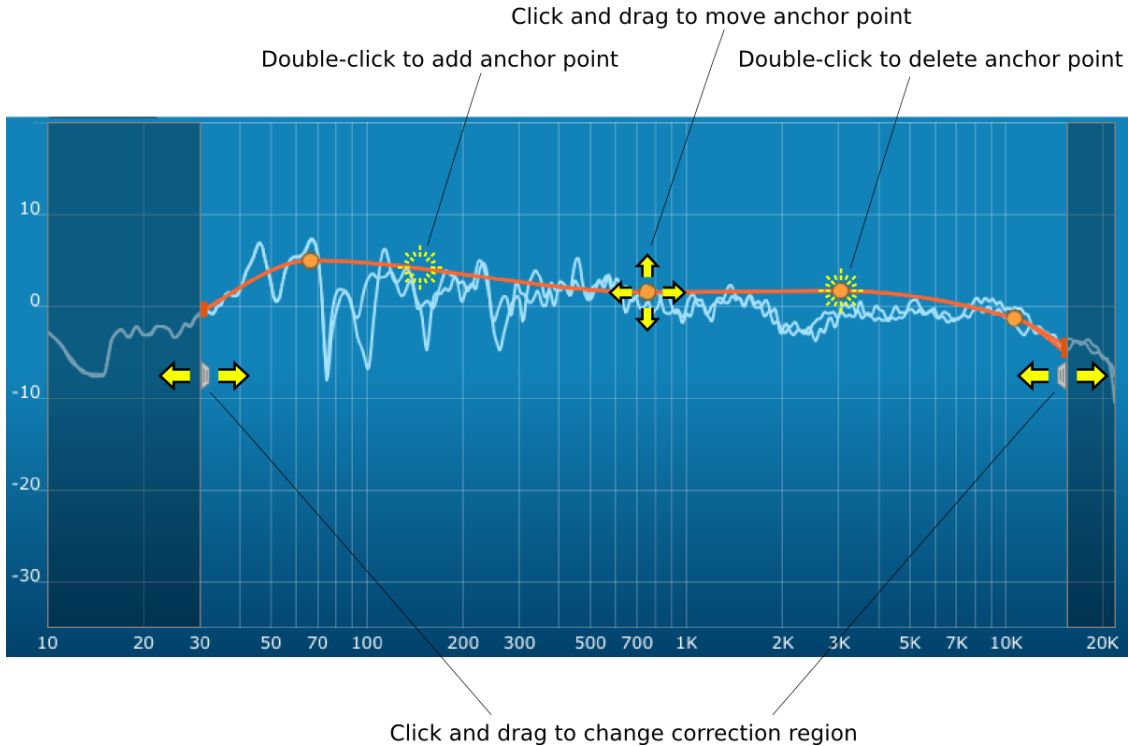

The regions to the left and right of the response graphs that are shaded in a darker color are excluded from correction. You can adjust the range of frequency correction for your system and environment. For example, low-frequency noise (traffic, machinery) may be present in some environments, so it is best to adjust the frequency range to exclude these frequencies from the correction. Or, you may be happy with the in-room response at higher frequencies, so you can set the frequency region to limit correction to the modal region (up to 300 Hz, in a typical room).

To alter the frequency region, drag the grey handles on either side of the graph. Note that you can't drag these handles over an anchor point, so you may need to move or delete an anchor point that is "in the way."

If the left and right channels are linked, the same target curve is used for both channels. To create separate target curves for the left and right channels, unlink the two channels as described in [Working with graphs](#).

8.2.3 Guidelines for target curve design

Care should be taken to create a target curve that works well with your speakers and room, as well as suiting your personal preferences. Small changes to the target curve can have significant effects on the tonal quality of the system, so it is important that you experiment with different target curves to find the optimum.

If you initially don't achieve a satisfactory result, please ensure that you have spread your measurements over a sufficiently large area and with sufficient variation in height. The following guidelines will help you understand how to adjust your target curve.

Low-frequency extension and boost

All loudspeakers have a natural low-frequency roll off. Setting the target curve to boost the region below the speaker's natural roll off frequency *may* result in overdriving the speakers, especially with smaller home loudspeakers and depending on your listening habits. A system with capable subwoofers integrated into it, however, will support much more low-frequency output.

The auto-target estimates the low-frequency roll-off and curve, and in some cases may include some amount of boost if it estimates that the speakers are capable of handling it. You should determine by *listening* whether this estimate is suitable for your speakers, then adjust the target curve accordingly.

High-frequency "tilt"

The target curve is the desired measured response of loudspeakers *in a room*, in contrast to measurements made of a loudspeaker during its design under anechoic (measured in free space) conditions. While high-quality loudspeakers are usually designed for a flat on-axis anechoic response, these same speakers when placed into a listening room will tend to have a downward-sloping or "tilting" response at high frequencies, due to the effects of limited dispersion at high frequencies and greater acoustic absorption.

A completely flat in-room response is therefore usually not desirable and will tend to sound thin or bright. Start with a target curve that follows the natural behavior of your speakers in your room, and then experiment with greater or lesser degrees of tilt in the treble region to obtain the most natural timbral balance.

Low-frequency adjustment

A completely flat response at low frequencies, with complete elimination of peaks due to room modes, may sound light in the bass. Often, a slight increase in the target curve below 100 Hz will give a more balanced sound, yet without introducing audible irregularities in bass response.

Magnitude response dips

In some cases, it may be helpful to adjust the target curve to follow dips in the magnitude response. This can occur where, for example, the listening area is very close to the speakers and the measurements exhibit a dip caused by the vertical response of the speakers themselves. In such a case, adjusting the magnitude response to follow the dip will avoid making the speakers sound worse elsewhere in the room. (You may also wish to try a different set of measurement locations.)

Unlinking channels

In almost all cases, the left and right channels should remain linked for target curve adjustment, to ensure that both speakers produce the same response across the listening area. In certain unusual circumstances,

such as where the magnitude response dip discussed in the previous point shows up in only one speaker, you can try unlinking the left and right channels and making separate adjustments.

8.2.4 Saving and loading target curves

To allow you to experiment with different target curves, you can save a target curve to a file and reload it at a later time. To save a target curve, click on the **Save Target** button. If the left and right channels are linked, then the shared target curve will be saved to the file. If the channels are not linked, then the currently visible target is saved to the file.

To load a target curve, click on **Load Target**. Note that loading a target will erase the current target, so be sure to save it first if needed. If the channels are linked, then the target curve will be loaded to both channels. If the channels are not linked, then the target will be loaded to the currently visible channel.

8.3 GENERATING CORRECTION FILTERS

Once you have a target curve set to your satisfaction, click on the **Optimize** button. DLCT may at this time contact the Dirac license server to verify its license, so you will need to be connected to the Internet. If a firewall is in place, it must allow HTTP (normal web traffic) to pass.

The status bar will update with progress of the algorithm. Execution may take some time, depending on the speed of your computer. When the algorithm completes, the predicted average magnitude response will be shown in green. (The predicted impulse response can be viewed by clicking on the **Impulse** button.)

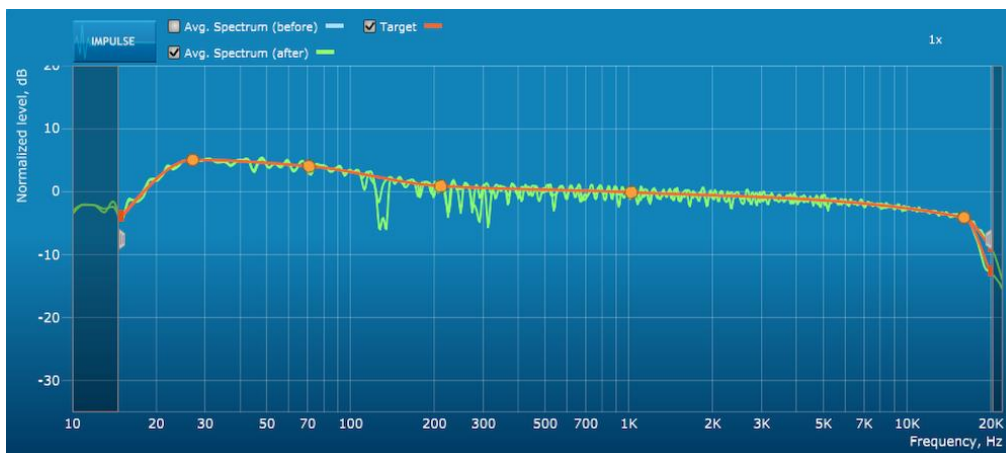

To download the generated filters into the processor, click the **Proceed** button or on the **Export** tab on the left.

8.4 LOADING FILTER SETS

The **Export** tab initially shows four empty “slots” for filter sets (a filter set is one filter for the left channel and one filter for the right channel). Filter sets are managed with a “drag and drop” metaphor:

- To load the most recently generated filter set into the processor, drag the box at the top left (labeled “Living room 2018-06-11” in the example) and drop it onto an empty slot (*).
- To remove a filter set, click on its name (oriented vertically), drag it from the slot and drop it on the trashcan icon at the top right.
- To load a filter set into a slot that already has filters loaded, first delete the loaded filter set by dragging it onto the trashcan icon. Then drag and drop the current filter set onto the now-empty slot.

This example screenshot shows Slot 1 loaded:

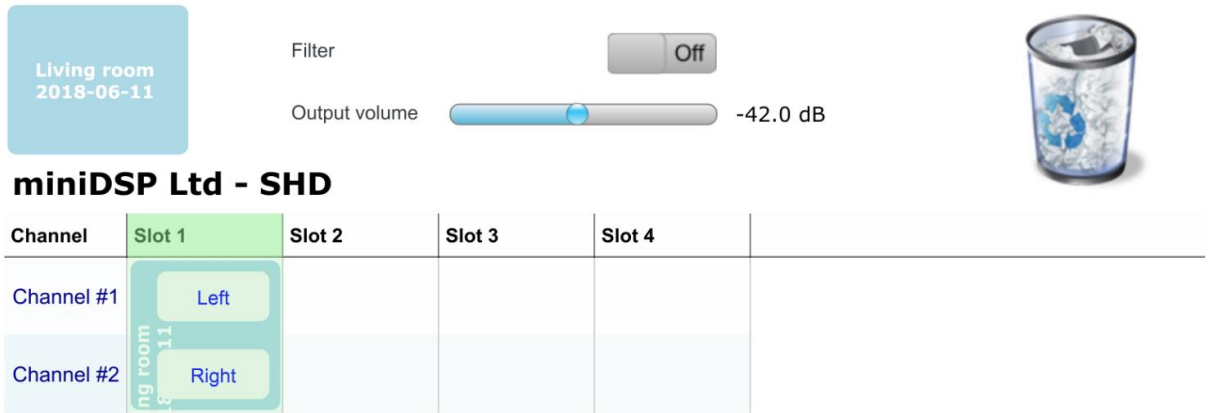

The two additional controls on this tab are:

Filter

Turn this on to enable the Dirac Live® correction filters. This can also be done from the front panel or remote control.



Output volume

Adjust the slider to adjust the output volume of the processor. This can also be done from the front panel or remote control.



(*) If using advanced/backend processing, ensure that you load the filters into the same slot as the preset selected when running the measurements for Dirac Live calibration.



SHD Studio only. For headphone listening, you will probably want to leave a slot without Dirac Live filters loaded.

9 CONFIGURING BACKEND PROCESSING

If you intend to run a configuration that is more than straight stereo room correction processing, then you will need to configure the back-end processing prior to running Dirac Live calibration. Typically, this applies to applications such as subwoofer integration and two-way active speakers.



If you are just using straightforward stereo room correction processing, you don't need to read this section.

9.1 HOW IT WORKS

To understand how the SHD Series processor combines Dirac Live with miniDSP's audio processing, refer to the signal flow diagram below:

- One of the stereo input sources is selected by the user and passed to two channels of Dirac Live processing for digital room correction (DRC).
- The Dirac Live outputs are fed into a 2-in 4-out matrix mixer. The two input channels to the mixer, labeled "Dirac 1" and "Dirac 2" in the plugin interface, are routed and mixed in any manner to the four output channels.
- The outputs from the mixer are processed through a comprehensive set of DSP functions – crossover filters (high pass and low pass), parametric EQ, and individual gain and delay adjustments. These are all optional – you can configure them if you want to, according to your particular application.

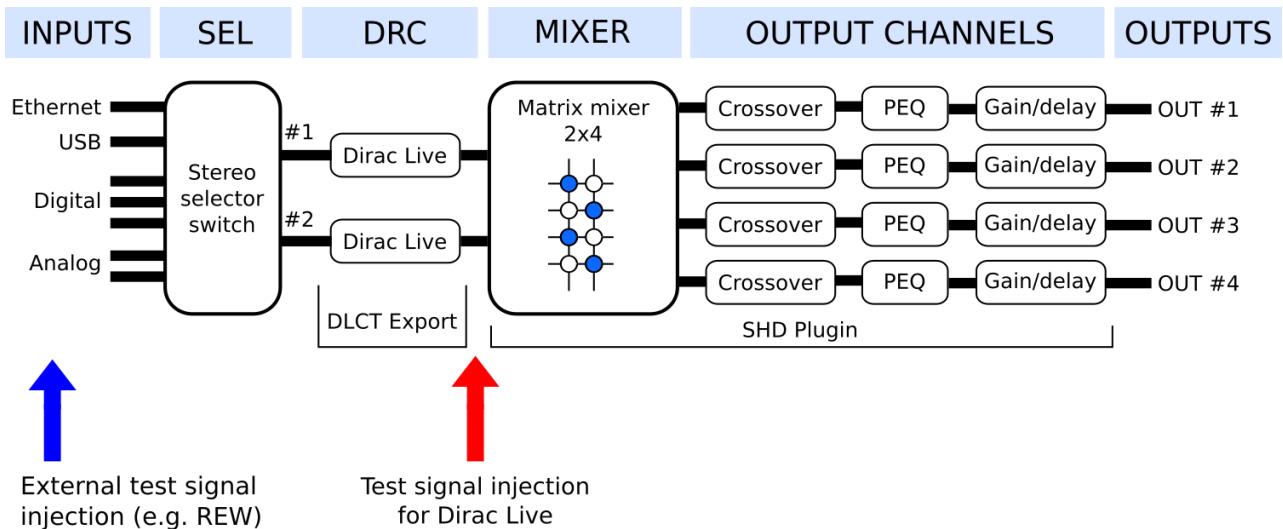

The two "halves" of the signal flow are configured by two different programs – DLCT, and the SHD plugin. In the case of DLCT, correction filters are loaded into four "slots." In the case of the SHD plugin, configurations are set up or loaded in one of four presets. When a preset is selected, the corresponding Dirac Live filters **and** the plugin configuration are loaded into the working DSP memory.

Because the Dirac Live test signal originates in the Dirac Live blocks, it “sees” all of the processing configured by the SHD plugin. Similarly, if one is using an external program such as REW (Room EQ Wizard) to set up the plugin, its test signal will be passing through the Dirac Live blocks in addition to those set up by the plugin. Therefore:

1. When performing a Dirac Live calibration, the correct preset must be selected. For example, if you have set up preset 1 for subwoofer integration, preset 1 must be selected when running the Dirac Live calibration. Selecting a preset with the default configuration will not give the right result. (It will be obvious in this example, but it may not always be.)
2. If configuring the plugin with the aid of REW (Room EQ Wizard) or another measurement program, ensure that there are no Dirac Live filters loaded for that preset. If necessary, use DLCT to unload filter sets.

While the description of the signal processing flow is from inputs to outputs (left to right in the diagram), the order in which you configure the processor is usually the reverse, for the above reasons.

9.2 PLUGIN USER INTERFACE

The main user interface of the plugin has several areas, indicated in this screenshot:



Note: Do not attempt to run the SHD plugin and DLCT at the same time. *If you are running DLCT, quit before starting the SHD plugin.*



During *initial* configuration of the processor, it is strongly recommended that any connected amplification be powered off.

9.3 CONNECTING TO THE PROCESSOR

Connect the SHD Series processor to a USB 2.0 port on your computer if it is not already. Then click on the **Connect** button:



If successful, the button changes to a green tick. For the sake of brevity, this state is referred to as “online” whereas the earlier state with the circular arrows is referred to as “offline.” When the plugin is online, any changes made in the SHD plugin are immediately transferred to the processor and will be heard in the audio signal. This is also referred to as “synchronized.”

If you have just upgraded the plugin or made any changes to any parameters in the plugin interface, one of these dialog boxes will appear:

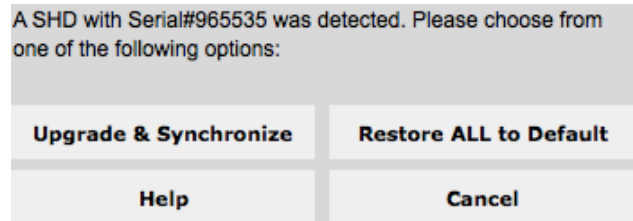
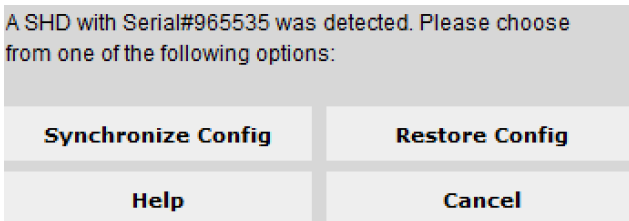

Synchronize Config

Download the data for the currently selected configuration into the processor. Note that this applies only to data that can be changed in the SHD plugin — Dirac Live filters are not changed. After downloading the configuration data, the plugin is online.

Restore Config

Restore the data in the currently selected configuration to the factory defaults. This applies only to data that can be changed in the SHD plugin — Dirac Live filters are not reset. When using this option, any connected equipment should be muted or powered off until you have set the configuration to a working state. Configuration data will be lost, so if needed, ensure that you have saved the configuration to a file prior to using this option. After restoring, the plugin is online.

Upgrade & Synchronize

This button may appear after upgrading the plugin. It is similar to Synchronize Config, but also upgrades the processor’s internal DSP data and software.

Restore ALL to default

This button may appear after a plugin upgrade. It upgrades the processor’s internal DSP data and software and then sets all four configurations to default.

Help

This option brings up a help screen explaining the options.

Cancel

This option cancels the attempt to connect to the processor. The plugin will remain offline.

9.4 KEY FEATURES

This section summarizes the key features of the plugin. For detailed information, see Section 10.

9.4.1 Master control

Once the plugin is online, the items in the Master Control area are active. The **Mute** button disables all audio output:



The **Master Volume** display shows the current volume setting. The master volume can be set directly by clicking here and typing a new value. It can also be set with the front panel, remote control or from within DLCT:

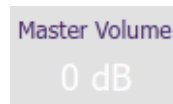

The **Dirac Live** button turns Dirac Live processing on and off. This can also be done with the front panel, remote control or from within DLCT:



The **IP Address** and **Auto** fields are for use with networked control of the plugin using the miniDSP [WI-DG Wifi/Ethernet to USB bridge](#). See the [Wi-DG User Manual](#) for details.

9.4.2 Configuration/preset selection

The set of data that controls the back-end processing is called a *configuration*. This includes crossovers, parametric EQ and the routing matrix. It does not include the master volume or mute status.

Four configurations are stored onboard. The currently selected preset is indicated by a dark background:

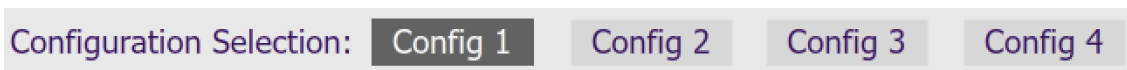

To switch to a different preset, just click on the desired button:



9.4.3 Inputs

The **Routing** tab displays two input channel status strips. Note that these are status only – there are no user-adjustable controls. They are active only when the plugin is online.

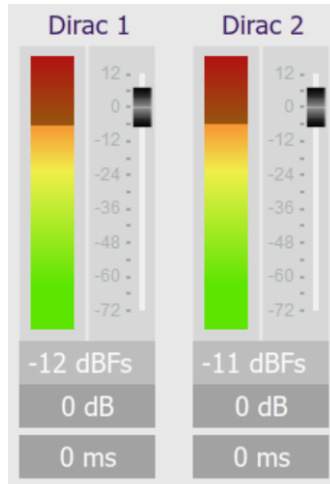

9.4.4 Input selection

When the plugin is online, the currently selected input appears next to the “Dirac Inputs” label. Click on the current input name to drop down a selector menu, from which you can select a different input. The input can also be selected from the front panel or with a remote control.

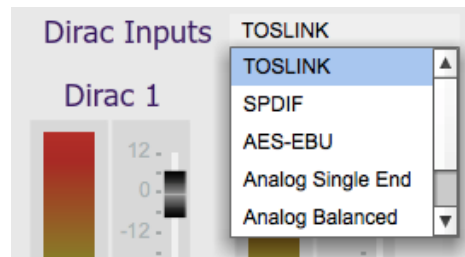

9.4.5 Matrix mixer

The matrix mixer on the Routing tab directs input channels (along the left) to output channels (along the top). To turn on routing for a cross-point, click on that cross-point. Both inputs can be mixed to each output if desired, and the mix level can be set individually for each input.

	Output1	Output2	Output3	Output4
Dirac 1	0dB	Off	Off	Off
Dirac 2	Off	0dB	Off	Off

9.4.6 Outputs

The **Outputs** tab displays a row of four output channel control strips. All output channels are identical.

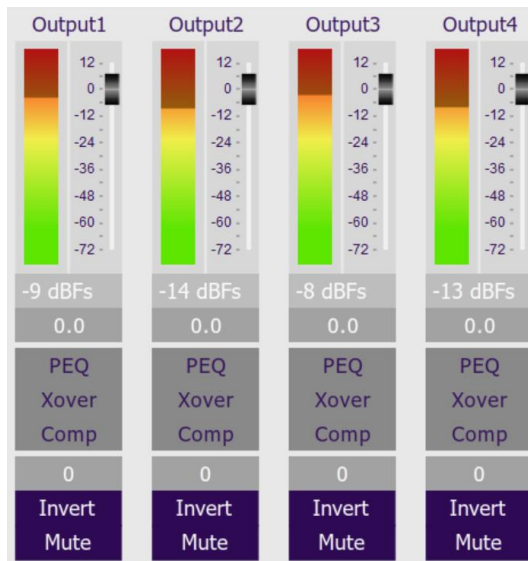

Each channel has an individual gain adjustment slider, and a graphical and numerical display of the current signal level on that channel. A comprehensive set of signal processing functions is accessed with the buttons PEQ (parametric EQ), Xover (crossover) and Comp (compressor/limiter).

9.5 ACOUSTIC MEASUREMENT FOR BACK-END CONFIGURATION

Best results are obtained with the aid of appropriate acoustic measurements. For applications like subwoofer integration, additional software may not be needed, as DLCT can be used as the measurement tool.

9.5.1 Using DLCT as a measurement tool

After configuring the SHD plugin, quit it and start DLCT. Proceed through the steps in Section 7, but do only the first measurement in the center of the listening area, then proceed to the Filter Design screen. The display will show the measurements of the left and right channels:

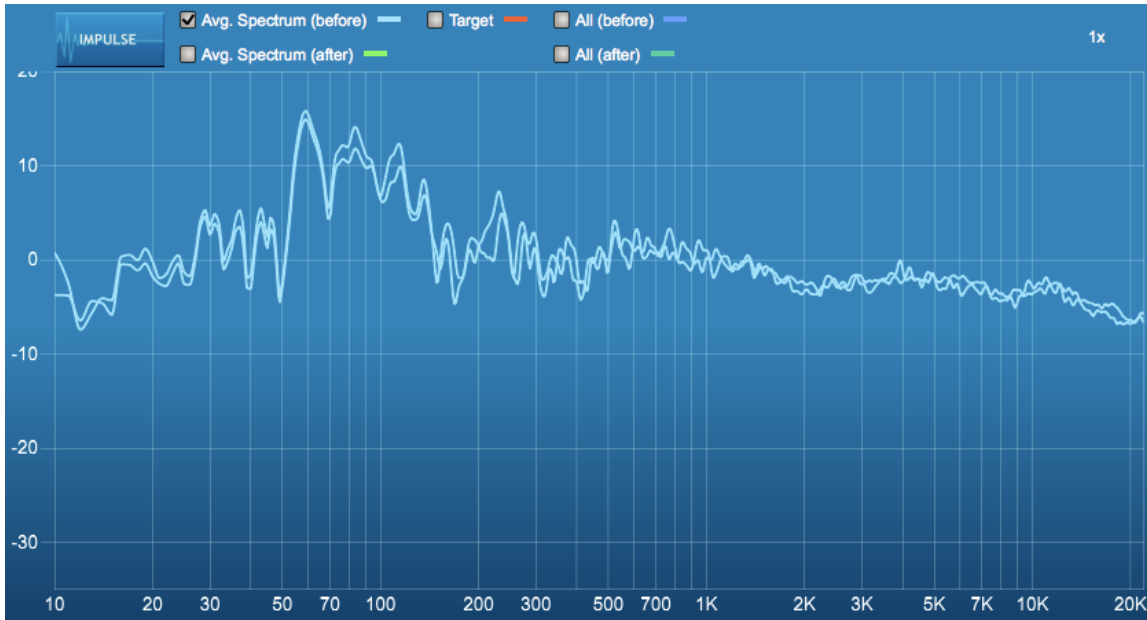

Save the project if you wish to preserve the measurement. Then quit DLCT and start the SHD plugin to make further configuration changes.

9.5.2 Using Room EQ Wizard

For faster configuration changes and for measurements that require gating such as those used for a two-way active speaker, Room EQ Wizard (or another acoustic measurement program) should be used. We have many application notes describing how to use REW on our website:

- <https://www.minidsp.com/applications/acoustic-measurements>



You can also use REW to measure the system response *after* performing Dirac Live calibration. However, remember that a measurement at a single point in space does not reflect how Dirac Live works, as Dirac Live uses a total of nine measurements. Furthermore, Dirac Live does not do a simple averaging of the nine measurements.

9.6 SAMPLE PLUGIN CONFIGURATIONS

This section provides a quick overview of a range of common configurations. For details on any of the processing blocks mentioned, see Section 10.

9.6.1 Stereo room correction

In a stereo room correction configuration, the plugin is set up to route the selected input through to output channels 1 and 2. This diagram illustrates the connections:

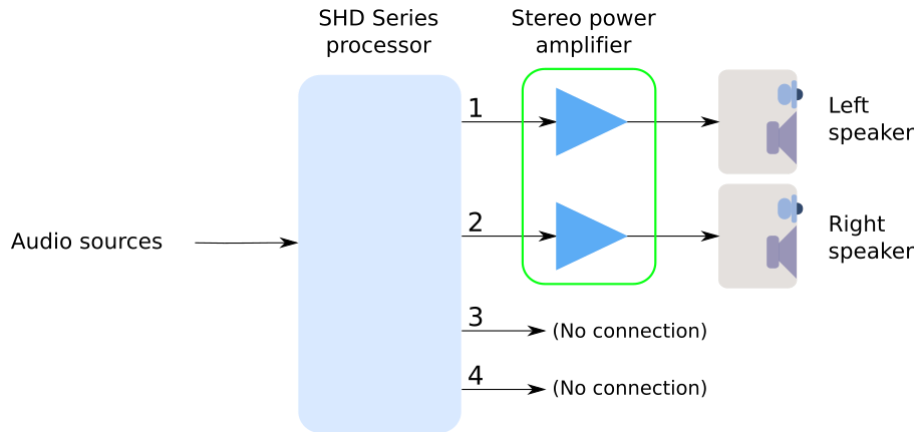

Note: this is the default configuration of the SHD processor and is largely set up by a “Reset to Default” operation.

On the **Outputs** tab:

- Rename the output channels (from left to right) to “Left”, “Right”, “Unused” and “Unused”.
- Mute channels 3 and 4 (labeled “Unused”).
- Check that the crossover filters of channels 1 and 2 (“Left” and “Right”) are bypassed:



On the **Routing** tab, set the matrix like this:

	Left	Right	Unused	Unused
Dirac 1	0dB	Off	Off	Off
Dirac 2	Off	0dB	Off	Off

After you have set up the SHD plugin, save your configuration to a file. Then quit the SHD plugin, start DLCT and run Dirac Live calibration as described in Sections 7 and 8.

9.6.2 Add single subwoofer

This diagram illustrates the connections for stereo room correction with a single subwoofer:

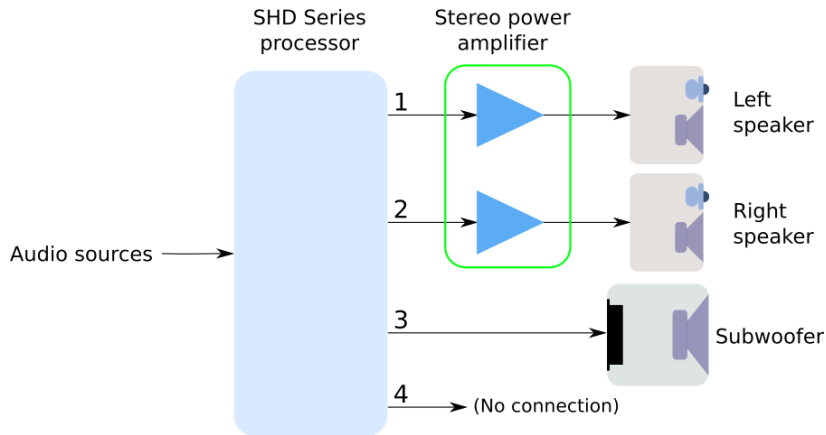

On the **Outputs** tab:

- Rename the output channels (from left to right) to “Left Sp”, “Right Sp”, “Sub” and “Unused”.
- Mute channel 4 (“Unused”).
- Set a high pass crossover filter on channels 1 and 2 (“Left Sp” and “Right Sp”). For example:

HIGH PASS FILTER SETTINGS		LOW PASS FILTER SETTINGS	
Cut off frequency	80	Cut off frequency	1000
Bypass filter	BW 24dB/oct	Bypass filter	LR 48dB/oct
Filter Type	BYPASS	Filter Type	BYPASSED

- Set a low pass crossover filter on channel 3 (“Sub”). For example:

HIGH PASS FILTER SETTINGS		LOW PASS FILTER SETTINGS	
Cut off frequency	1000	Cut off frequency	80
Bypass filter	LR 48dB/oct	Bypass filter	BW 36dB/oct
Filter Type	BYPASSED	Filter Type	BYPASS

On the **Routing** tab, set the matrix like this:

	Left Sp	Right Sp	Sub	unused
Dirac 1	0dB	Off	0dB	Off
Dirac 2	Off	0dB	0dB	Off

You may wish to do acoustic measurements to check and fine-tune your subwoofer crossover settings. The main thing that you want to avoid is a large dip around the crossover frequency; for more detail, check [this link](#). After you have set up the SHD plugin, save your configuration to a file. Then quit the SHD plugin, start DLCT and run Dirac Live calibration as described in Sections 7 and 8.

9.6.3 Add dual subwoofers

This diagram illustrates the connections for stereo room correction with two subwoofers:

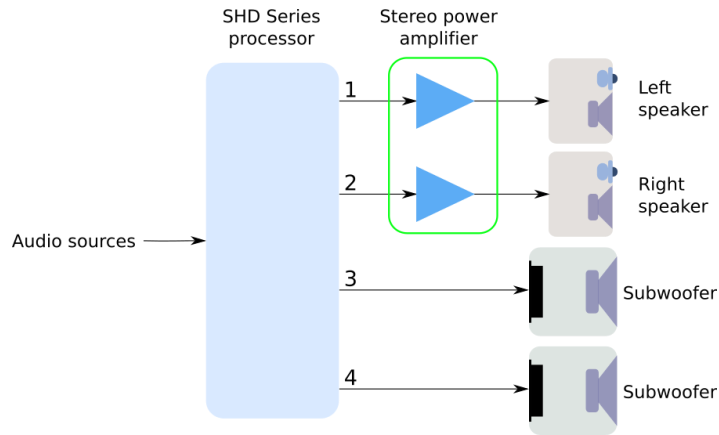

On the **Outputs** tab:

- Rename the output channels (from left to right) to “Left Sp”, “Right Sp”, “Sub 1” and “Sub 2”.
- Set a high pass crossover filter on channels 1 and 2 (“Left Sp” and “Right Sp”). For example:

HIGH PASS FILTER SETTINGS		LOW PASS FILTER SETTINGS	
Cut off frequency	80	Cut off frequency	1000
Bypass filter	BW 24dB/oct	Bypass filter	LR 48dB/oct
Filter Type	BYPASS	Filter Type	BYPASSED

- Set a low pass crossover filter on channels 3 and 4 (“Sub 1” and “Sub 2”). For example:

HIGH PASS FILTER SETTINGS		LOW PASS FILTER SETTINGS	
Cut off frequency	1000	Cut off frequency	80
Bypass filter	LR 48dB/oct	Bypass filter	BW 36dB/oct
Filter Type	BYPASSED	Filter Type	BYPASS

On the **Routing** tab, set the matrix like this:

	Left Sp	Right Sp	Sub 1	Sub 2
Dirac 1	0dB	Off	0dB	0dB
Dirac 2	Off	0dB	0dB	0dB

You may wish to do acoustic measurements to check and fine-tune your subwoofer crossover settings. The main thing that you want to avoid is a large dip around the crossover frequency; for more detail, check [this link](#). After you have set up the SHD plugin, save your configuration to a file. Then quit the SHD plugin, start DLCT and run Dirac Live calibration as described in Sections 7 and 8.

9.6.4 Stereo supporting woofers/FAST

In a configuration with two full range speakers supplemented by supporting woofers (sometimes known as “FAST”), the plugin is set up to split the frequency range to the woofer and full range speakers. This diagram illustrates the connections:

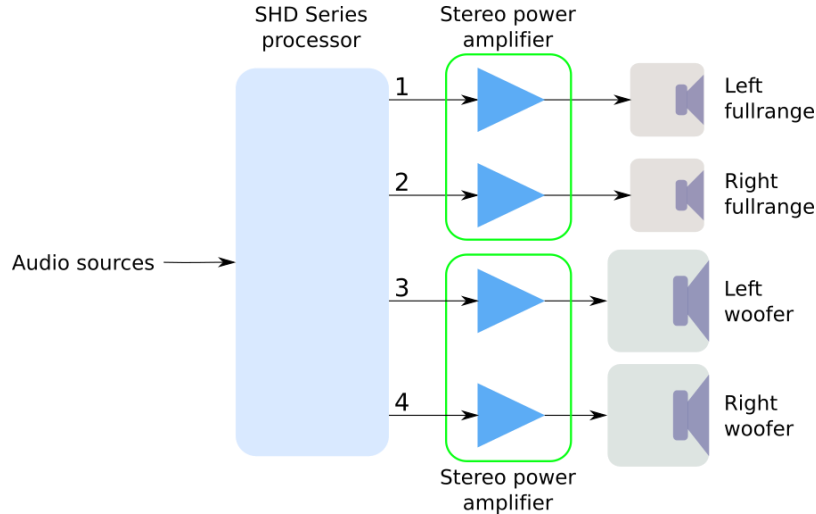

On the **Outputs** tab:

- Rename the output channels (from left to right) to “Left FR”, “Right FR”, “Left W” and “Right W”.
- Set a high pass crossover filter on channels 1 and 2 (“Left FR” and “Right FR”). For example:

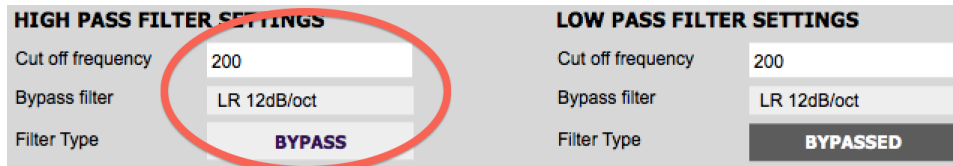

- Set a low pass crossover filter on channels 3 and 4 (“Left W” and “Right W”). For example:

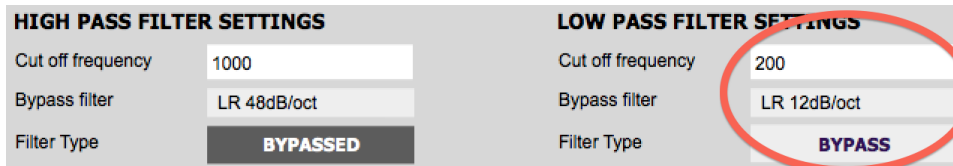

On the **Routing** tab, set the matrix like this:

	Left FR	Right FR	Left W	Right W
Dirac 1	0dB	Off	0dB	Off
Dirac 2	Off	0dB	Off	0dB

It is recommended that you take acoustic measurements to check and fine-tune your crossover settings. After you have set up the SHD plugin, save your configuration to a file. Then quit the SHD plugin, start DLCT and run Dirac Live calibration as described in Sections 7 and 8.

9.6.5 Two-way active speaker

The miniDSP SHD Series processors can implement a two-way active speaker as well as provide room correction. This diagram illustrates the connections:

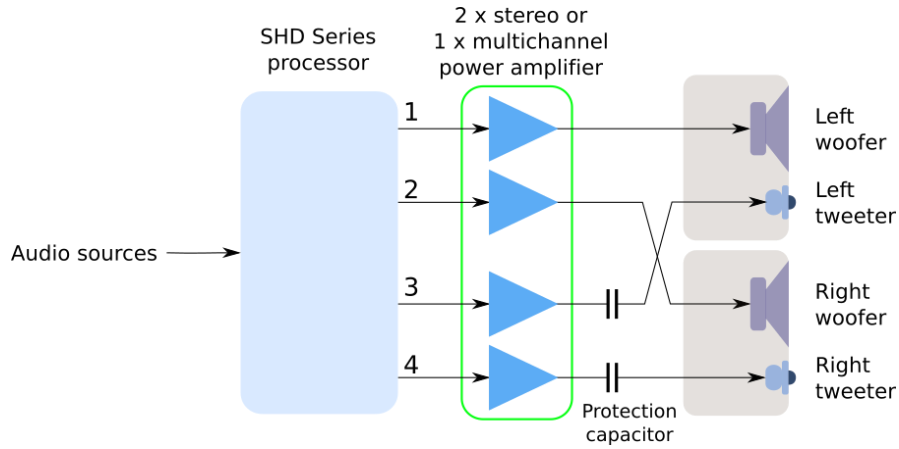

On the **Outputs** tab, rename the output channels to “Left W”, “Right W”, “Left Tw”, and “Right Tw”.

	Left W	Right W	Left Tw	Right Tw
Dirac 1	0dB	Off	0dB	Off
Dirac 2	Off	0dB	Off	0dB

On the **Routing** tab, set the matrix like this:

On the **Outputs** tab again:

- Use Room EQ Wizard or a similar program to measure each individual driver (woofer and tweeter) and equalize their response flat with the PEQ blocks. This procedure is the same as for the 2x4 HD, as described in our app notes [at this link](#).
- Set up your high pass and low pass crossover filters. This procedure is the same as for the 2x4 HD, as described in our app notes [at this link](#). This is a typical low pass setting for the woofers:

HIGH PASS FILTER SETTINGS		LOW PASS FILTER SETTINGS	
Cut off frequency	80	Cut off frequency	3000
Bypass filter	BW 24dB/oct	Bypass filter	LR 24dB/oct
Filter Type	BYPASSED	Filter Type	BYPASS

This is a typical high pass setting for the tweeters:

HIGH PASS FILTER SETTINGS		LOW PASS FILTER SETTINGS	
Cut off frequency	3000	Cut off frequency	5000
Bypass filter	LR 24dB/oct	Bypass filter	LR 48dB/oct
Filter Type	BYPASS	Filter Type	BYPASSED

After you have set up the SHD plugin, save your configuration to a file. Then quit the SHD plugin, start DLCT and run Dirac Live calibration as described in Sections 7 and 8.

10 PLUGIN REFERENCE

This section provides full details on each of the plugin processing blocks.

10.1 INPUT CHANNEL STATUS

Each input channel strip displays useful information about the levels and Dirac settings on that channel. The plugin must be online to display this information.

Channel label

The name of the channel. These are set to “Dirac 1” and Dirac 2” and cannot be renamed.

Level meter, Current RMS level

Displays the current signal level in real time.

Dirac Live level

Graphical and numerical display of the gain (in dB) that Dirac live has set for this channel.

Dirac Level delay

Numerical display of the delay (in milliseconds) that Dirac live has set for this channel.

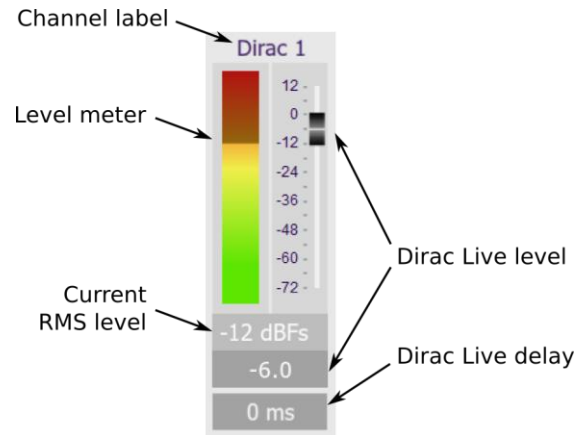

10.2 ROUTING

The **Routing** matrix mixer is used to direct input channels (along the left) to output channels (along the top). To turn on routing for a cross-point, click on that cross-point. At each cross-point, the gain of the signal being mixed can be adjusted to a value between -72 and +12 dB. To adjust the gain, right-click on the cross-point and a gain control will appear. Adjust the gain with the slider or by typing in the value directly, then click **close**.

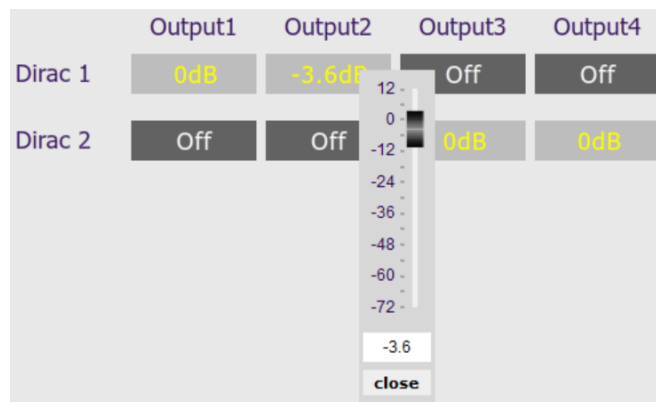

SHD Studio only. For headphone use, create a preset that routes Dirac 1 to Output3 and Dirac 2 to Output4. This preset should not have Dirac Live room correction filters loaded.

10.3 OUTPUT CHANNELS

Each output channel has a complete "strip" of controls.

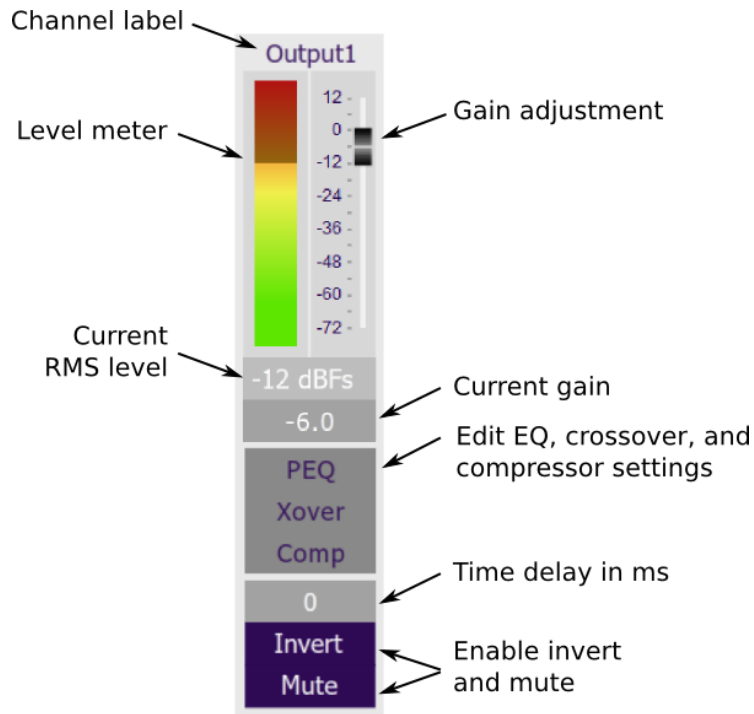

10.3.1 Channel label

Each output channel has a customizable label, which is shown at the top of the channel strip. This label also appears on the **Routing** matrix. To change the label, click on it, type a new label (up to eight characters), and press the Return key.

10.3.2 Level metering and gain adjustment

Level meter, current RMS level

Displays the current signal level both graphically and numerically in real time. The plugin must be online to display signal levels.

Gain adjustment, current gain

The gain of each channel can be adjusted by moving the Gain Adjustment slider, or by typing the desired gain into the Current Gain text box. The maximum gain setting is 12 dB, and the minimum gain setting is -72 dB. (0 dB, the default, is unity gain or no change in level.)

10.3.3 Parametric EQ

Parametric equalization (PEQ) is a flexible type of equalization filter. It can be used to correct for errors in loudspeaker output, to compensate for acoustic room effects, and to tailor the overall system response for best sound. Click on the PEQ button to open the parametric equalizer settings window:

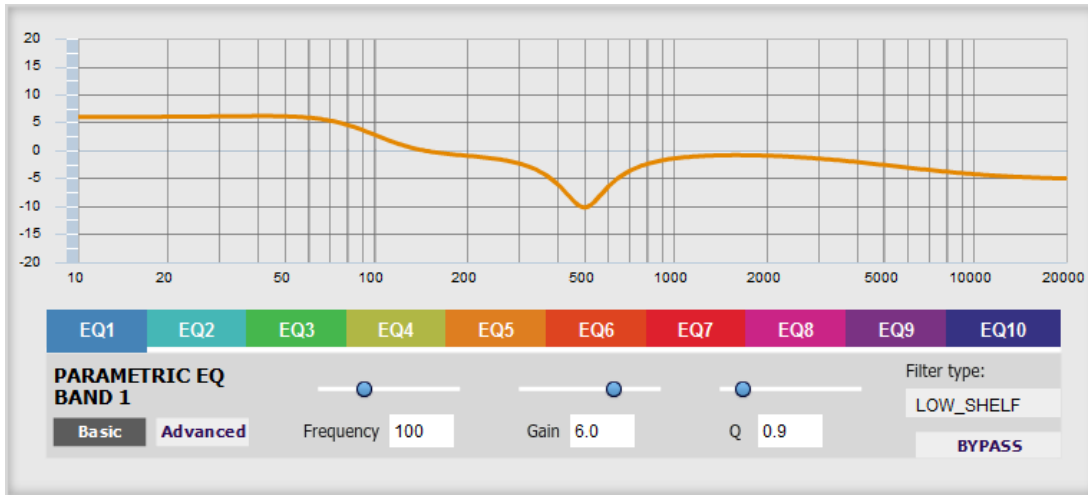

There are ten parametric EQ filters on each output channel. The window displays a frequency response graph showing the combined response of all enabled parametric filters on that channel. For example, the screenshot above shows a response curve created with a low-shelf boost filter at 100 Hz, a dip at 500 Hz, and a high-shelf cut filter at 5000 Hz.

Hovering the mouse over the curve brings up an overlay showing the frequency and the gain at that frequency.

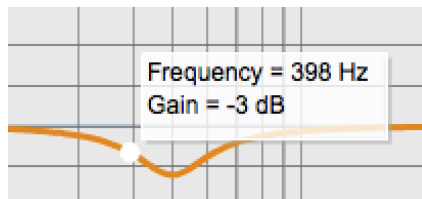

Each channel can be linked to one other channel. When a channel is linked to another, the PEQ settings of that channel are mirrored to the other. Typically, corresponding channels on the left and right are linked: for example, left and right tweeter and left and right woofer. To link a channel, select the other channel from the drop-down menu at the top left of the **PEQ** display, and click the **Link** checkbox.



EQ band selection

Click on the tabs **EQ1**, **EQ2**, etc. to display the parameters for that filter.

Basic/Advanced

By default, each filter is in basic mode, and shows the controls described below. Advanced mode enables custom biquad programming for almost infinite flexibility in filter implementation. This is described in [Custom biquad programming](#) on page 72.

Filter type

Selects the type of filter:

PEAK

Create a dip or a peak in the frequency response.

LOW_SHELF

Reduce or increase part of the frequency spectrum *below* a given frequency.

HIGH_SHELF

Reduce or increase part of the frequency spectrum *above* a given frequency.

SUB_EQ

Create a dip or a peak in the frequency response at low frequencies (10 to 50 Hz). This filter type is similar to PEAK but gives more accurate results for low frequencies. Note that activating any SUB_EQ filter reduces the number of available filters on that channel from ten to nine.

Frequency

For the PEAK and SUB_EQ filter types, this is the center frequency of the peak or dip. For the HIGH_SHELF and LOW_SHELF filter types, this is the frequency at which the gain is half of the set value.

Gain

For the PEAK and SUB_EQ filter types, this is the gain in dB at the center frequency. For the HIGH_SHELF and LOW_SHELF filter types, this is the gain in dB reached at high or low frequencies respectively. A filter has no effect if its gain is set to 0 dB. Gain can be adjusted in increments of 0.1 dB up to +/- 16 dB.

Q

Q controls the “sharpness” of the filter. For the PEAK and SUB_EQ filter types, lower Q gives a broader peak or dip, while higher Q gives a narrower peak or dip. For the HIGH_SHELF and LOW_SHELF filter types, Q controls how quickly the filter transitions from no gain to maximum gain.

Bypass

The **Bypass** button enables or disables a filter. The filter is bypassed if the button is "lit". (Note that all other filters are still operational unless individually bypassed.) A filter will also have no effect if its gain is set to 0.0.



10.3.4 Crossover

Each output channel has independent high pass and low pass filters. Click on the **Xover** button to open the crossover settings window:

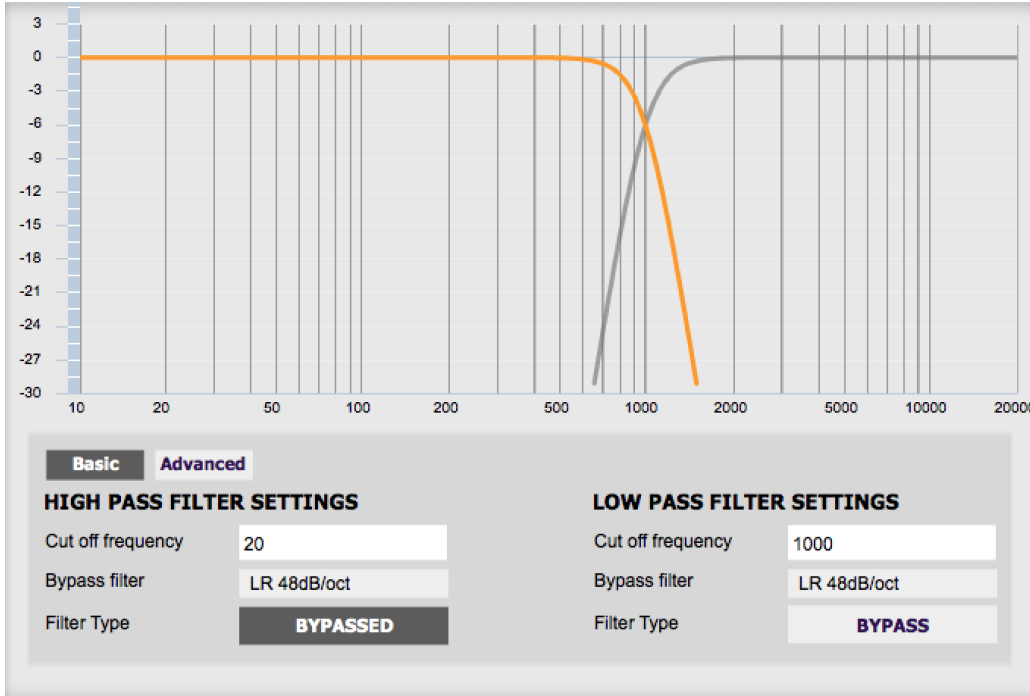

Crossovers “split” the frequency band to send to different drivers. In a two-way loudspeaker, a *low pass* filter is used to remove high frequencies from the signal sent to the woofer, and a *high pass* filter is used to remove low frequencies from the signal sent to the tweeter. When integrating a subwoofer, high pass filters are used on the speakers and a low pass filter on the subwoofer. A crossover filter can also be used to limit low frequency content delivered to a speaker or subwoofer, to help protect it from over-excursion.

Unlike conventional analog crossovers, the flexibility of DSP allows a completely arbitrary mix of different filter slopes and types. Filters can be set at any frequency or disabled completely. This allows maximum flexibility in matching your crossover to the acoustic characteristics of the loudspeaker drivers.

The current channel is displayed in orange, with the others displayed in grey. Hovering the mouse over the curve brings up an overlay showing the frequency and the attenuation at that frequency.

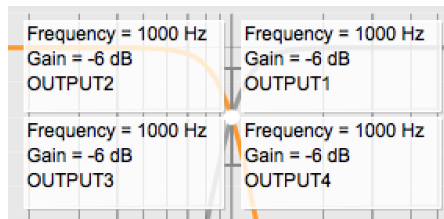

Basic/Advanced

By default, the crossover is in basic mode, and shows the controls described below. Advanced mode enables custom biquad programming for almost infinite flexibility in crossover filter implementation. This is described in [Custom biquad programming](#) on page 72.

Cutoff Frequency

Sets the nominal cutoff frequency of the crossover. In actual fact, the crossover has a more or less gradual transition from “full on” to “full off,” as determined by the filter slope.

Filter type

Selects the type and slope of the filter. The steeper the slope, the more quickly frequencies above or below the cutoff frequency are attenuated. There are three types of filter:

Butterworth (BW)

Available in 6, 12, 18, 24, 30, 36, 42, and 48 dB/octave, Butterworth crossover filters are 3 dB down at the cutoff frequency.

Linkwitz-Riley (LR)

Available in 12, 24, and 48 dB/octave, Linkwitz-Riley crossover filters are 6 dB down at the cutoff frequency.

Bessel

Available in 12 dB/octave only, a Bessel filter gives a more gradual roll-off through the crossover region.

Bypass

Clicking on the **Bypass** button disables or enables that high pass or low pass filter. The filter is bypassed when the button is "lit".



Each channel can be linked to one other channel. When a channel is linked to another, the crossover settings of that channel are mirrored to the other. Typically, the corresponding drivers on the left and right channels are linked: left and right tweeter, left and right woofer, and so on. To link a channel, select the other channel from the drop-down menu at the top left of the **Xover** display, and click the **Link** checkbox.



10.3.5 Compressor

The compressor reduces the gain of an output channel when the audio signal reaches a certain level as specified by the **Threshold** parameter. The gain of the channel will be progressively reduced as the signal increases above the threshold, according to the **Ratio** parameter. This can be used to limit the power delivered to speakers and thus reduce the risk of damage from overdriving.

This screenshot shows an example Compressor setting:

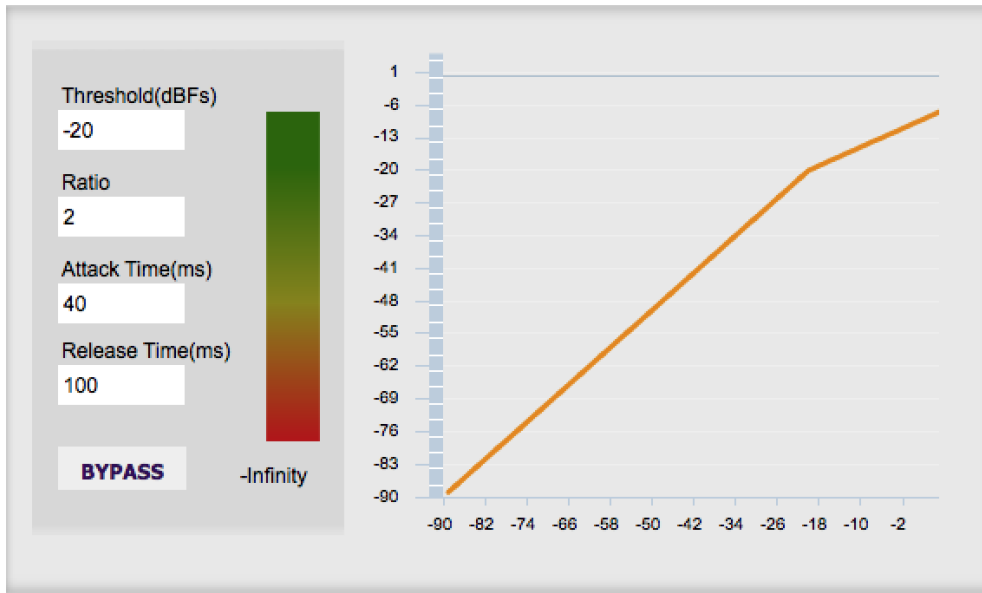

(Note that the compressor algorithm is bypassed by default, so click on the **Bypass** button to see the curve as shown here.)

In this example, the threshold is set to -20 dB, so the compressor will activate when the signal on that channel reaches -20 dB (relative to full output). The ratio is set to 2, so if the input signal level to the compressor then increases by 10 dB, the output level will increase by only 5 dB. If the input signal level to the compressor is at full scale (0 dB), then the output level will be limited to -10 dB.

Two additional parameters control the action of the compressor: the attack time and the release time. These two parameters govern how quickly the compressor activates when the signal level exceeds the threshold, and how quickly it deactivates when the signal level reduces. The optimum settings may need to be tuned by ear. For more information, see the Wikipedia article [Dynamic range compression](#).

10.3.6 Invert and mute

Each channel can be inverted in polarity and individually muted. When either of these options is selected, the visual indicator on the button is "lit":

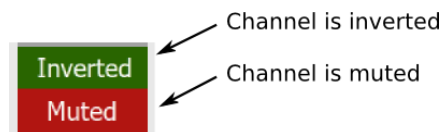

10.3.7 Time delay

A delay of up to 30 ms can be applied to each output channel. To set the delay, click in the delay entry box for a channel. The delay value can be entered numerically, and the up and down arrows can be used to change the delay in small (0.02 ms) increments.

The time delay corresponds to a distance. This distance is shown in centimeters below the entry box. The maximum time delay of 30 ms corresponds to a distance of approximately 10.3 meters (about 35 feet).

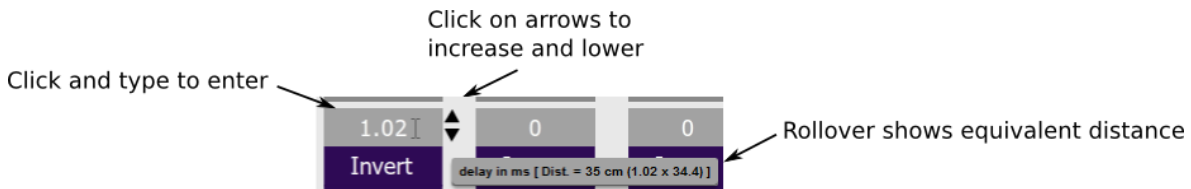

Note: The Dirac Live analysis algorithm *also* sets a time delay on the left and right channel. The time delay on the output channels should be used to time-align drivers for a two-way loudspeaker or to optimize subwoofer integration.

10.4 CUSTOM BIQUAD PROGRAMMING

Custom biquad programming is available in the PEQ and Crossover blocks. Its purpose is to allow you to directly provide the low-level parameters aka *biquad coefficients* that control the digital filters of the processor, thus providing an almost infinite degree of flexibility.

For example, you can create hybrid crossovers with staggered cutoff frequencies, create parametric EQ filters beyond those provided in the easy-to-use “basic” interface, implement a Linkwitz transform, or mix crossover and EQ biquads in the same block.

10.4.1 What’s a “biquad?”

A biquad is the basic unit of processing that is used to create digital filters. It can be described either with an equation or with a signal flow diagram, as shown here:

$$H(z) = \frac{b_0 + b_1 z^{-1} + b_2 z^{-2}}{1 + a_1 z^{-1} + a_2 z^{-2}}$$

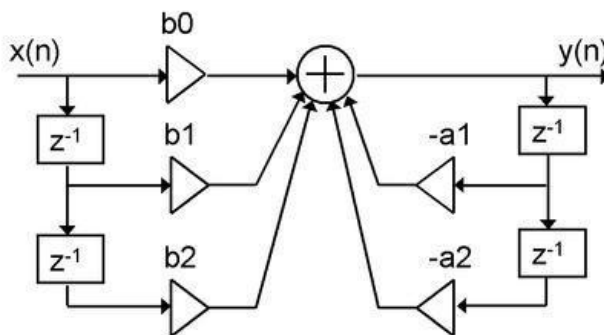

A single biquad like this can perform a great many functions, including all of the functions of a single parametric EQ filter, one 6 or 12 dB/octave high pass or low pass filter, and more. Biquads are combined in series (cascaded) to create more complex filters. The function that each biquad performs is determined by just five numbers: b_0 , b_1 , b_2 , a_1 , and a_2 . These numbers are called the *coefficients*.

10.4.2 Using custom biquad programming

Each crossover block and PEQ filter has a selector that switches it to advanced mode:



In advanced mode, the biquad coefficients can be pasted directly into the user interface. These coefficients must be calculated using a design program – see [Biquad design software](#) for suggestions.

Parametric EQ advanced mode

In the parametric EQ blocks, advanced mode allows each individual filter to be specified by its biquad coefficients. After pasting in the coefficients, click on the **Process** button.

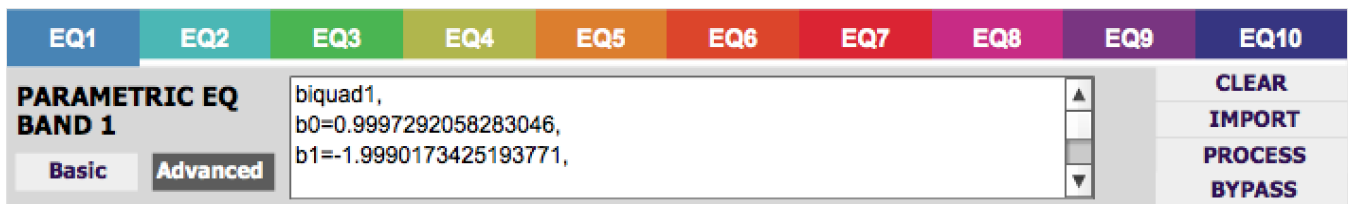

Parametric EQ file import (REW integration)

Multiple biquads in the parametric EQ block can be set at once by importing a coefficient file. This file can be generated by Room EQ Wizard (REW) or by other programs. The design program must be set for a **96 kHz** sample rate. The number of filters is limited to a maximum of ten.

This example illustrates the correct file format:

```
biquad1,
b0=0.998191200483864,
b1=-1.9950521500467384,
b2=0.996920046761057,
a1=1.9950521500467384,
a2=-0.9951112472449212,
biquad2,
b0=0.999640139948623,
b1=-1.9981670485581222,
...
biquad3,
...
biquad4,
...
biquad10,
b0=1.0010192374642126,
b1=-1.9950555192569264,
b2=0.9940580112181501,
```

```
a1=1.995060938714333,  
a2=-0.9950718292249559
```

Note that the last line must not have a comma at the end. If the file has less than ten biquads, then only that number of biquads will be imported. For example, if importing a file with six biquads, the first six filters will be set, and the last four will not be changed. (Note: if the last line ends with a comma, that counts as an extra biquad.)

If the file contains more than ten biquads, then an error will be reported and no filters will be changed.

Crossover advanced mode

The **Crossover** blocks have eight biquads for each output channel. In **Advanced** mode, all eight biquads need to be specified. After pasting in the coefficients, click on the **Process** button for them to take effect.



10.4.3 Biquad design software

Following are programs that can be used to design your biquad coefficients.

Biquad calculation spreadsheet

The community-developed biquad calculation spreadsheet allows many filter types to be calculated, including notch filters, Linkwitz transforms, and filters with arbitrary Q-factor. Access this spreadsheet here (requires Microsoft Excel):

- http://www.minidsp.com/images/fbfiles/files/All_digital_coefs_v1-20101026.zip

Room EQ Wizard (REW)

Room EQ Wizard is a free acoustic measurement and analysis tool, available for Windows, Mac and Linux platforms. It includes the ability to automatically generate a bank of parametric EQ biquads based on a measurement. These coefficients can be saved to a file from REW and then loaded into a PEQ block. Room EQ Wizard can be downloaded here:

- <http://www.roomeqwizard.com/#downloads>

For guidance on using this feature, please refer to the app note [Auto EQ with REW](#).

10.5 WORKING WITH CONFIGURATIONS

The data that controls the audio processing is called a *configuration*. The processor stores four configuration presets in its internal memory, which can be selected from the plugin or via remote control.

10.5.1 Online and offline mode

Initially, the plugin is *offline*. When the **Connect&Synchronize** button is used, the plugin downloads configuration data into the processor and goes *online*. Changes made in the plugin user interface therefore fall into two categories:

The plugin is online

The plugin user interface is “live” – that is, any changes made to the audio processing parameters in the user interface are immediately downloaded to the processor. The effect of these changes will thus be audible as the changes are made.

The plugin is offline

Changes made to audio processing parameters in the plugin user interface will be made locally in the plugin only. The next time the plugin goes online, these parameters will be downloaded to the processor (as long as the **Synchronize Config** button is pressed).



The configuration contained in the miniDSP hardware unit cannot be uploaded back to the computer. Therefore, you **must** save your configuration to a file if you wish to be able to recover from any changes you make while offline.

10.5.2 Selecting a configuration

The active configuration is selected by one of the four Configuration Selection buttons:



To switch to a different configuration, click on a different button. There are two cases:

The plugin is online

Audio processing will switch to the parameters of the selected configuration. If parameters of the selected configuration have been changed since the last time that configuration was synchronized, then a dialog will appear asking if you want to synchronize the configuration.

The plugin is offline

The user interface will update to show the parameters of the newly selected configuration. If this configuration is changed in the user interface, it will be downloaded to the processor the next time it is synchronized.

10.5.3 Saving and loading configurations

Configurations can be saved to and loaded from files. Each configuration is stored in a separate file. It is *very* strongly recommended that each configuration programmed into the processor be saved to a file, to ensure that the configuration is not lost if the processor is inadvertently reset.

To save the currently selected configuration to a file, drop down the File menu, then select **Save** and then **Save current configuration**. In the file box, select a location and name of the file, and save it.

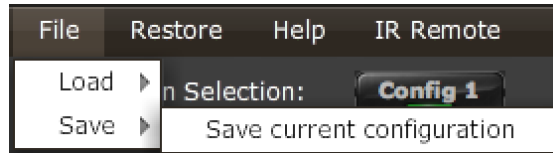

To load a configuration, first select the configuration preset that you wish to load into. Then drop down the File menu, select **Load**, and then **Load configuration to current slot**.

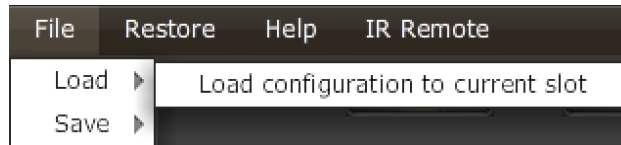

If the plugin is online, the new configuration data will be downloaded to the processor immediately. If the plugin is offline, the data will be loaded into the user interface only and will be downloaded to the processor the next time it is synchronized.



To copy a configuration from one preset to another, save the configuration to a file, then select a different configuration preset and load the file you just saved.

10.5.4 Relationship with Dirac Live

Each configuration preset in the SHD plugin corresponds to the same-numbered filter set configured in DLCT. For example, if the remote control or front panel is used to select preset 3, then both SHD configuration 3 and Dirac Live filter set 3 are loaded for audio processing.

The stored configuration file contains the data for the SHD plugin only. The Dirac Live filters must be loaded separately using DLCT.



10.5.5 Restoring to defaults

Configurations can be reset to the factory defaults from the Restore menu. There are two options:

Factory Default

Reset all four configuration presets to the factory default settings.

Current Configuration Only

Reset only the currently selected configuration preset to the factory default settings.

If the plugin is online, the configuration data on the processor (all or just one configuration, as selected) will also be reset to factory defaults. Otherwise, the reset will take place in the plugin user interface only, and the new configuration data will be downloaded to the processor next time it is synchronized.

10.6 KEYBOARD SHORTCUTS

The **SHD plugin** supports the use of the keyboard for many operations.

Tab

The Tab key moves the focus from the current user interface element to the next. A blue-grey surrounding box usually indicates the user interface element with the focus. Shift-Tab moves the focus in the opposite direction.

Up/down arrows

The up/down arrow keys (and in some cases, the left/right arrow keys) adjust the value of many parameters, if they have the focus:

- Gain adjustment
- Crossover frequency and filter type
- PEQ filter frequency, gain, and Q

Space

The Space bar toggles buttons that have two states, such as **Bypass**, **Invert**, and **Mute**, if they have the focus.

11 ADDITIONAL INFORMATION

11.1 SPECIFICATIONS

11.1.1 All SHD Series processors

Computer connectivity	Driverless USB 2.0 control interface for Windows and Mac OS X
USB audio input	XMOS asynchronous USB audio, 44.1 to 192 kHz stereo PCM, USB Audio Class 2 compliant. ASIO driver for Windows, driverless for macOS / OS X.
Digital audio inputs	<p>Digital audio source selectable from IR remote or front panel:</p> <ul style="list-style-type: none">• AES-EBU on Neutrik 3-pin female XLR / Isolated with digital audio transformer• SPDIF on RCA connector / Isolated with digital audio transformer• TOSLINK on Optical connector <p>The input signal is processed by a high quality onboard Asynchronous Sample Rate Converter for compatibility with most common sample rates (20-216kHz).</p>
Ethernet audio input	Audio streaming with Volumio, up to 192 kHz sample rate
Audio resolution	32-bit input and output resolution, 96 kHz internal sample rate
Audio processing	32-bit floating-point processor. Flexible matrix mixer, Dirac Live®, user-programmable IIR filtering, individual delays and gains per channel.
Filtering capabilities	<p>Dirac Live mixed-phase filtering, implemented with Dirac Live Calibration Tool for miniDSP (DLCT).</p> <p>User-programmable IIR filters: high pass and low pass crossover filters up to 48 dB/octave per output channel; ten biquad filters (parametric) EQ per output channel – peaking, low-shelf, and high-shelf types.</p>
Storage/presets	<p>All output channel settings controllable in real time from software user interface.</p> <p>4 onboard presets stored in local flash memory.</p>
Infrared remote	Basic remote supplied. Also supports “learning remote” capabilities (NEC, Philips, Sony) for third-party remotes.

11.1.2 SHD

Specifications as per “All SHD Series processors” on page 78, plus:

Analog audio inputs, unbalanced	Unbalanced stereo (2 channels) analog audio on RCA connectors <ul style="list-style-type: none">- Max input: 2V RMS- Input impedance: 47kΩ- THD+N @ 2Vrms: 0.0005% (RCA to USB)- Dynamic range: 114dB- Frequency response linearity / 20~20kHz -1dBFS: +/-0.5dB
Analog audio inputs, balanced	Balanced stereo (2 channels) analog audio on XLR connectors <ul style="list-style-type: none">- Max input: 4V RMS- Input impedance: 48kΩ- THD+N @ 2Vrms: 0.0003% (RCA to USB)- Dynamic range: 120dB- Frequency response linearity / 20~20kHz -1dBFS: +/-0.5dB
Analog audio outputs, unbalanced	Unbalanced analog audio (4 channels) on RCA connectors <ul style="list-style-type: none">- Full-scale output: 2V RMS- Output impedance: 100Ω- THD+N: 0.0005% (USB to RCA)- Dynamic range: 114dB- Frequency response linearity / 20~20kHz -1dBFS: +/-0.5dB
Analog audio outputs, balanced	Balanced analog audio (4 channels) on XLR connectors <ul style="list-style-type: none">- Full-scale output: 4V RMS- Output impedance: 200Ω- THD+N: 0.0003% (USB to RCA)- Dynamic range: 120dB- Frequency response linearity / 20~20kHz -1dBFS: +/-0.5dB
Digital audio outputs	Four channels of digital audio (two stereo pairs, OUT 1&2 and OUT 3&4), available as SPDIF on RCA connector / Isolated with digital audio transformer.
Power supply	Universal mains supply, 110 – 240 V AC
Dimensions (H x W x D)	41.5 x 429 x 236 mm



11.1.3 SHD Studio

Specifications as per “All SHD Series processors” on page 78, plus:

Digital audio outputs	Four channels of digital audio (two stereo pairs, OUT 1&2 and OUT 3&4), available on two sets of outputs: <ul style="list-style-type: none">• AES-EBU on Neutrik 3-pin male XLR / Isolated with digital audio transformer• SPDIF on RCA connector / Isolated with digital audio transformer
Headphone output	6.35 mm stereo jack. Cirrus Logic CS43130 DAC/headphone driver, driven from the same signal as OUT 3&4. Detailed analog specifications TBC.
Power supply	12V DC external supply, EU/US/AU/UK plug adaptors provided
Dimensions (H x W x D)	41.5 x 214.5 x 206 mm

11.2 PLUGIN AND DSP UPGRADE

miniDSP occasionally provides an upgrade to the plugin, to improve stability or performance or to add new features. The procedure is essentially the same as initial installation in Section 6, but with some additional points to note.

To upgrade, log into the miniDSP website and drop down the menu at the top right. Click on User Downloads.

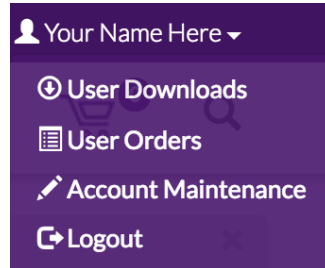

Click on the **SHD series** heading. First check the written instructions on the download page and note if there is more to do than just upgrade the plugin – for example, if there is a firmware update, or if the DSP program needs to be updated.

1. Click on the Download button at the right.

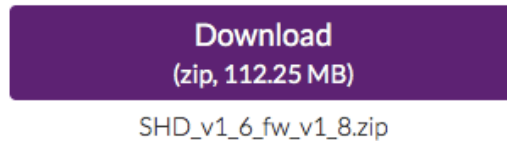

2. Unzip the downloaded file (on Windows, right-click and select “Extract All...”; on Mac, double-click).
3. Install the newly downloaded plugin as described in Section 6.
4. If the instructions on the download page say to update the DSP program, start the plugin, click the Connect button, drop down the Restore menu and select **Refresh DSP Program**. (This is safe to do as a matter of course after each plugin update. Your configuration data is not overwritten or reset.)

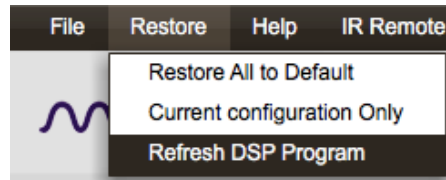

5. If the instructions on the download page say that there is a firmware update included, follow the instructions in section 11.4.
6. Confirm the updated software versions from the Help -> About... menu:

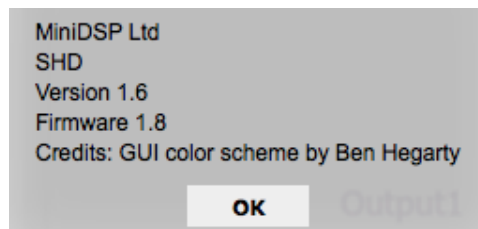

11.3 VOLUMIO SOFTWARE UPDATE

To check for an update to the Volumio software, open the web interface and drop down the gear menu at the top right. Select the **System** entry.

On the System page, click on the Check Updates button. If an update is available, you will see the details of the update, like this:

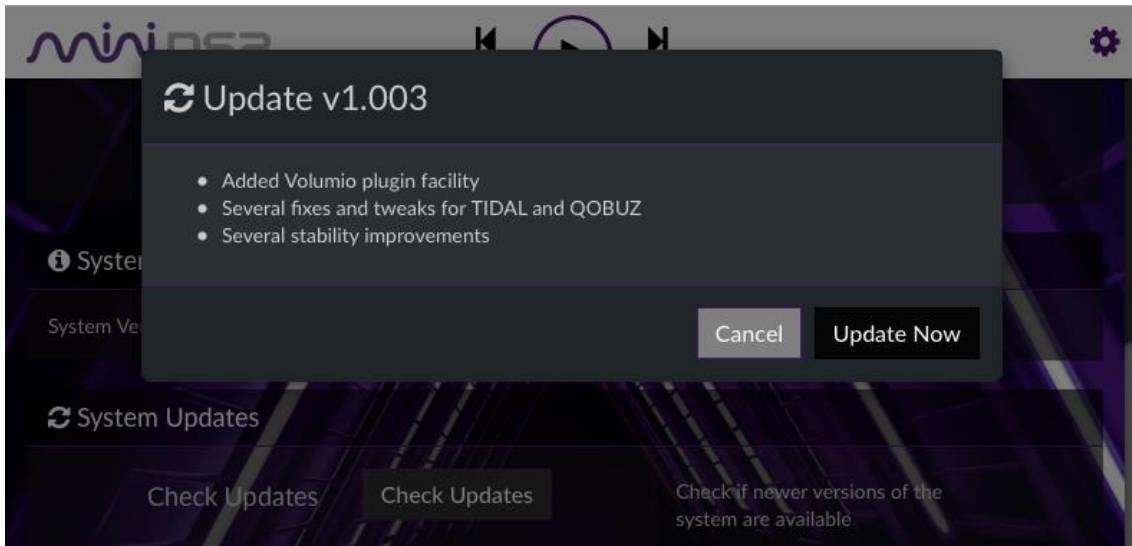

Click on Update Now. You will see a progress bar:

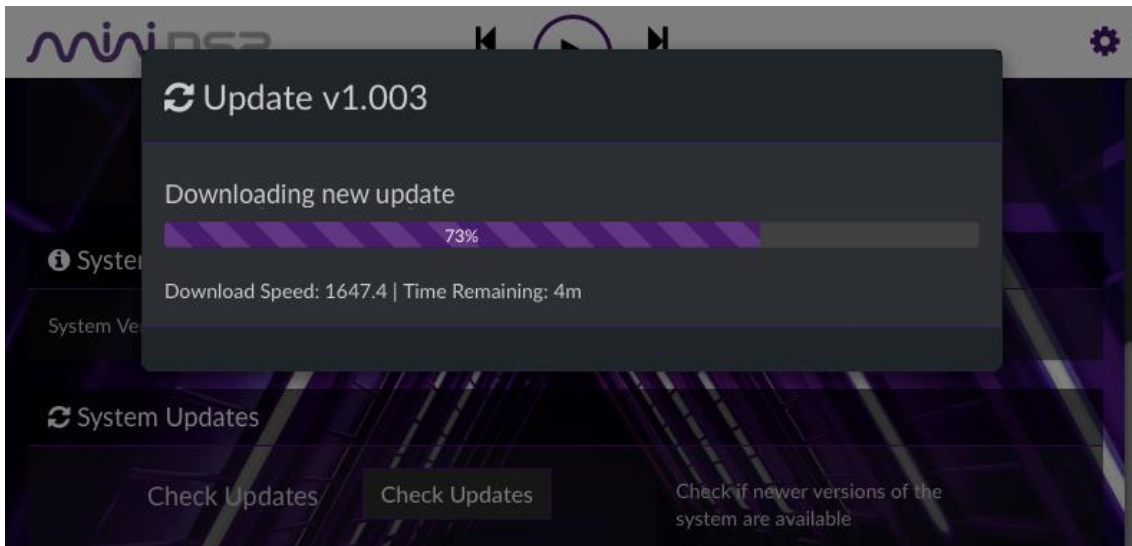

When the update completes, Volumio will automatically restart. After the webpage returns, it is important to **refresh the page in your browser**. This ensures that any updates to the user interface itself are updated in your browser.

11.4 FIRMWARE UPGRADE

miniDSP may occasionally provide an upgrade to the processor’s MCU firmware to enable new features. To upgrade the MCU firmware, first download the latest version of the SHD software package from the **User Downloads** section of the miniDSP website, then extract it on your computer (on Windows, right-click and select “Extract All...”; on Mac, double-click).



DO NOT DISCONNECT THE USB CABLE OR POWER FROM THE PROCESSOR WHILE FIRMWARE UPGRADE IS IN PROGRESS. DOING SO MAY “BRICK” YOUR PROCESSOR.

11.4.1 Windows

1. Connect the SHD Series processor to your computer via USB (if not already connected) and power it on.
2. Navigate to the **XMOS_Firmware\Firmware_Upgrade_Tools\Windows\miniDSPUAC2Dfu** folder of the software download.
3. Double-click on the **miniDSPUAC2Dfu.exe** program to run it:

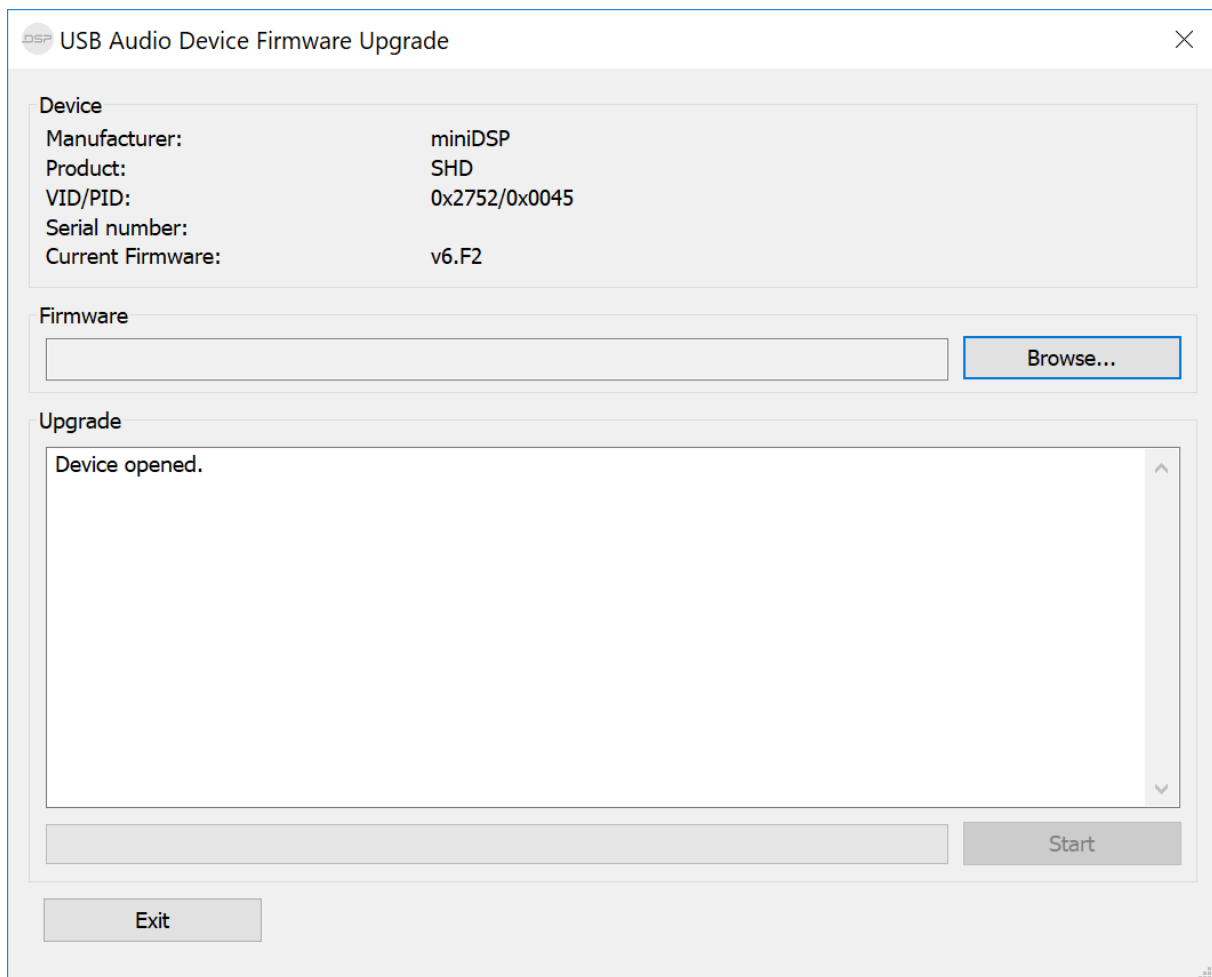

- Click on the **Browse** button and select the firmware file from the **XMOS_Firmware** folder of the software download. It will have a name like "SHD_v1.8.bin." (The version number "v1.8" may change.)
- Click on the **Start** button.
- You will get a progress bar as the upgrade proceeds:

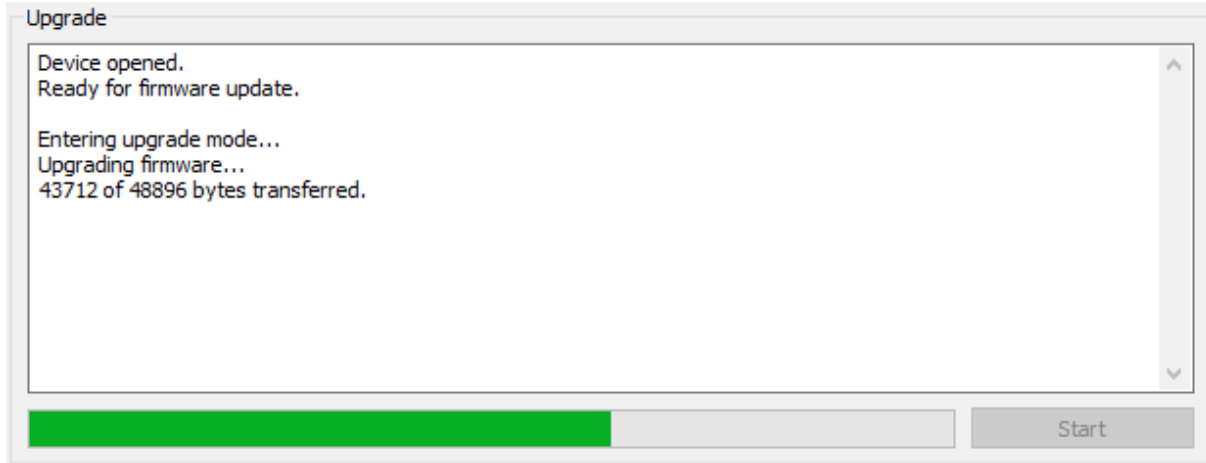

- Once the firmware upgrade completes, you will see a message that the upgrade completed successfully:

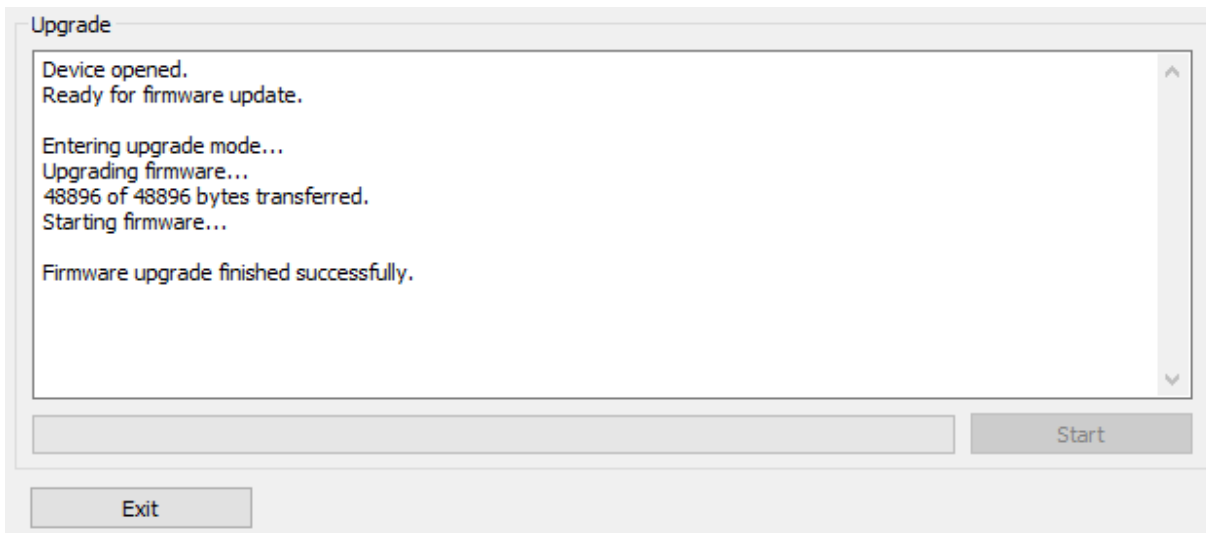

- Click on **Exit**.
- That's it! You're done. You can now use your SHD Series processor with the new functionality.

11.4.2 macOS / OS X

1. Connect the SHD Series processor to your computer via USB (if not already connected) and power it on.
2. Navigate to the **XMOS_Firmware/Firmware_Upgrade_Tools/Mac** folder of the software download.
3. Double-click on the **DFU Utility.app** program to run it:

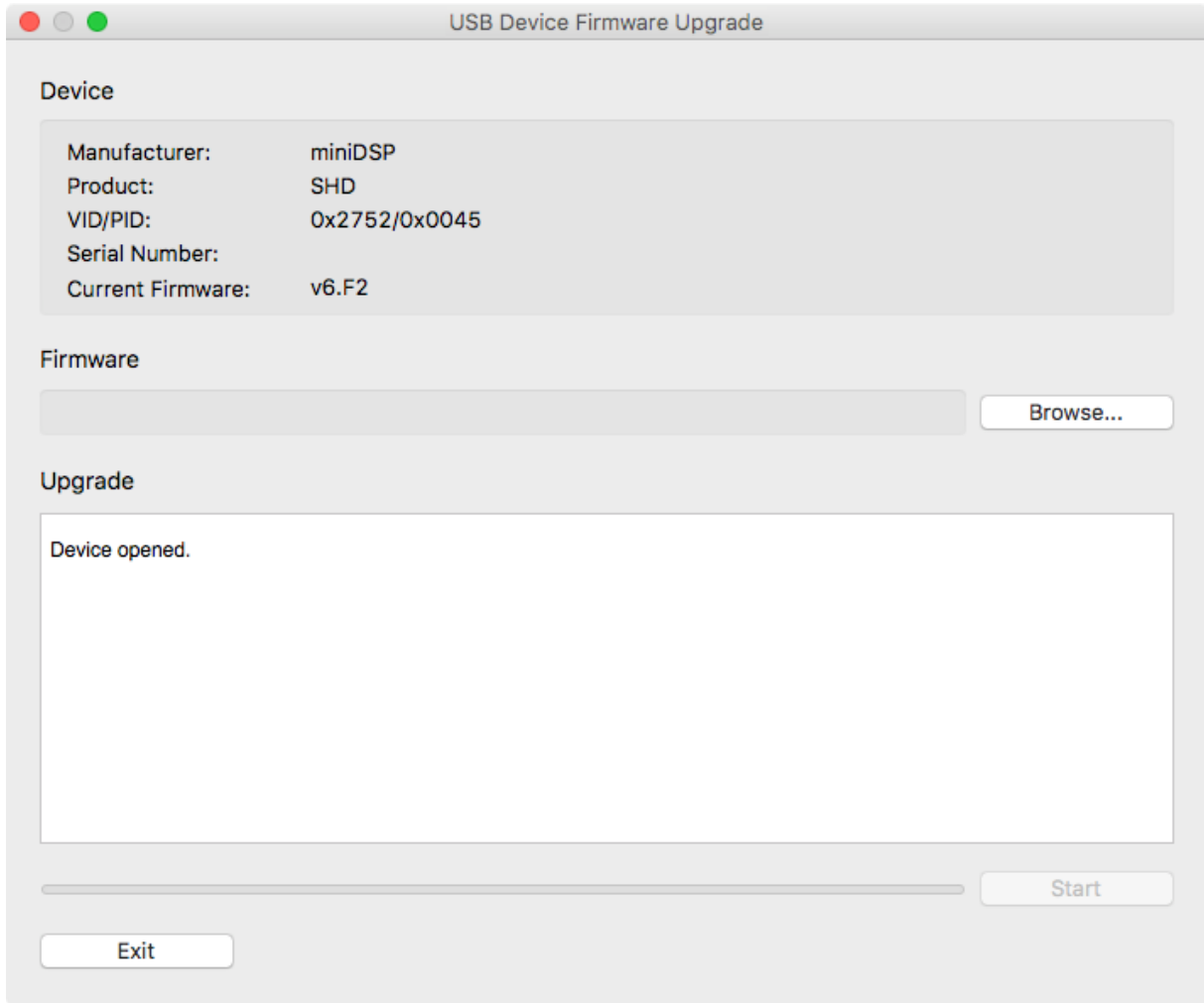

4. Click on the **Browse** button and select the firmware file from the **XMOS_Firmware** folder of the software download. It will have a name like "SHD_v1.8.bin." (The version number "v1.8" may change.)
5. Click on the **Start** button.
6. You will get a progress bar as the upgrade proceeds:

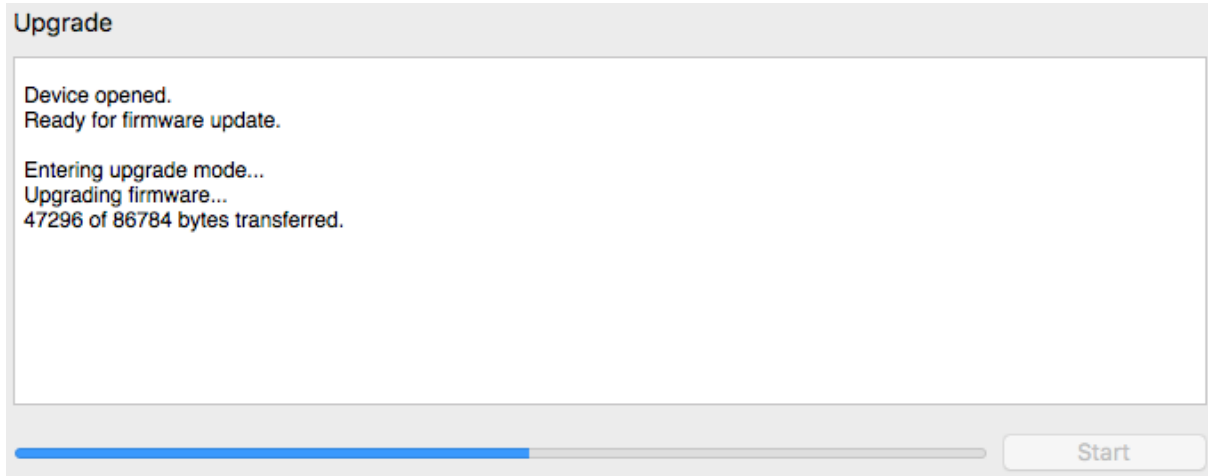

7. Once the firmware upgrade completes, you will see a message that the upgrade completed successfully:

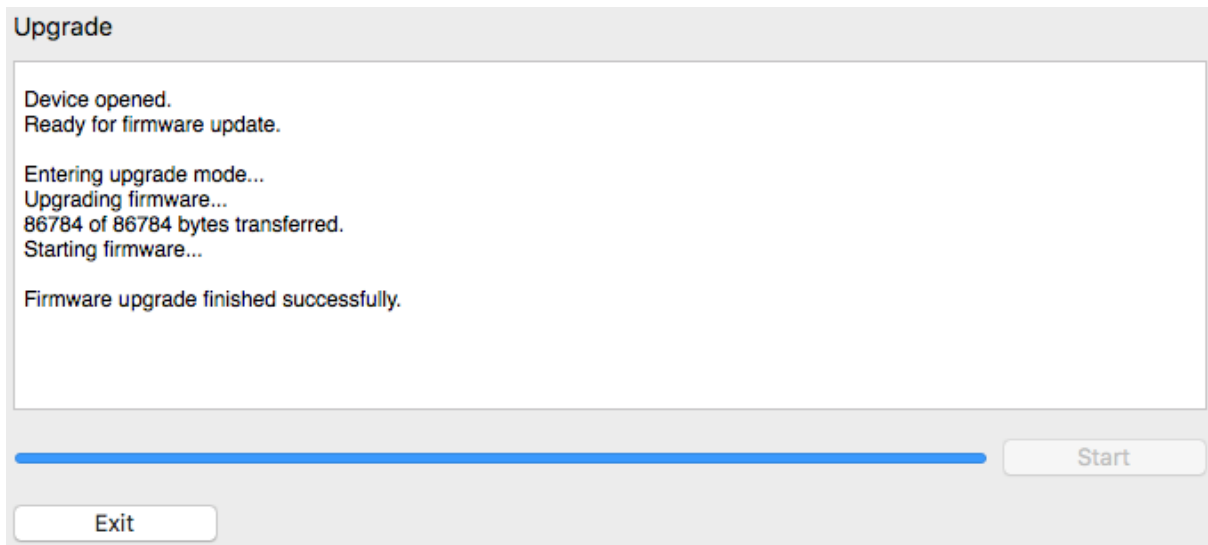

8. Click on **Exit**.
9. That's it! You're done. You can now use your SHD Series processor with the new functionality.

11.5 TROUBLESHOOTING

The following table lists the most common causes of issues. If following this table does not provide a solution, see [Obtaining Support](#).

11.5.1 SHD plugin

1	Cannot install software	a. Confirm that you downloaded and installed the required frameworks first (see Software Installation).
2	SHD plugin running in background but not showing	a. The Adobe Air environment may need a network connection the first time you run a plugin. Close the plugin program, ensure that your computer has a network connection, and restart the plugin. b. The Adobe Air environment may require a version update. Download the latest version from http://get.adobe.com/air/ .
3	SHD plugin cannot connect	a. Check that the USB cable to the processor is firmly connected. b. Reset the processor by power-cycling the unit.
4	No signal showing on input meters in SHD plugin	a. Check the cabling from your source. b. Check that your source is playing audio and that it is not muted or have volume control turned down. c. Check that the plugin is synchronized with the hardware unit.
5	Low audio on outputs	a. Check the cabling from the processor to your amplifiers. b. Check that your amplifiers are turned on and that any volume controls are turned up. c. Check that the input and output meters are showing signal. d. Check that master mute is not enabled. e. Check the master volume level. f. Check that your crossover frequencies are correct e.g. that you don't have high pass and low pass frequencies incorrectly set. g. Check that the matrix mixer is sending the correct inputs to the correct outputs.
6	Audio sounds distorted	a. Check the output meter and ensure that you are not overloading the outputs. If necessary, reduce the output gain and/or the amount of boost in the EQ blocks.
7	Audio is coming through the wrong outputs	a. Check the cabling from the processor to your amplifiers. b. Check that you have correctly set up the matrix mixer to send the correct inputs to the correct outputs.
8	Cannot reload a configuration	a. Confirm the file format of your file (.xml). b. Confirm the version of the file.

11.5.2 DLCT

1	The SHD Series processor doesn't appear in the Sound System tab	<ul style="list-style-type: none"> a. Check that the USB cable to the processor is firmly connected. b. Check that you do not have any other program running that is attempting to communicate with the processor, such as the SHD plugin. c. Check that you have installed and run the miniDSP version of the Dirac Live software, called Dirac Live Calibration Tool for miniDSP. d. Go to the Sound System tab and click the Rescan button.
2	The measurement test signal produces no output	<ul style="list-style-type: none"> a. Ensure that the processor is connected correctly into the audio system. b. Check that the downstream amplification is powered on. c. Check that the downstream amplification is not muted and doesn't have gain/trim controls set to zero. d. Quit DLCT, open the SHD plugin and click Connect. Connect an analog source to the inputs, and confirm that signal levels are seen on input and output meters. e. Check that master mute is not enabled.
3	No input from measurement microphone	<ul style="list-style-type: none"> a. Check that the USB cable to the UMIK-1 is securely seated. b. Check that the UMIK-1 is selected in the Mic Config tab. c. Remove any USB hubs and extensions.
4	Insufficient recording level	<ul style="list-style-type: none"> a. Increase microphone level in the Output & Levels tab. b. Go to the Control Panel and view the Recording tab of the Sound pane. Select the UMIK-1 and view its Properties. In Levels, set the gain to 100. c. Increase system output volume.
5	Unable to generate correction filters (Optimize button)	<ul style="list-style-type: none"> a. Check that your computer is connected to the Internet and able to pass HTTP (web) traffic. b. Check that you do not have any other program running that is attempting to communicate with the processor, such as the SHD plugin.



11.6 OBTAINING SUPPORT

1. Check the forums on minidsp.com to see if this issue has already been raised and a solution provided.
2. Contact miniDSP via the support portal at minidsp.desk.com with:
 - a. The product information obtained from the SHD plugin's About button and the Sound System tab of **Dirac Live Calibration Tool (DLCT)**.
 - b. A clear explanation of the symptoms you are seeing.
 - c. A description of troubleshooting steps (see [Troubleshooting](#)) performed and your results.

11.7 OPEN SOURCE LICENSES

The Volumio portion of the SHD Series processors runs on a separate ARM processor and is subject to various open-source licenses. To view the complete list of open source licenses and credits, connect to the web interface using your web browser and select System from the menu, then “Credits and Open Source Licenses.”

If you would like a copy of the GPL v2.0 source code contained in this product shipped on a DVD, you may obtain the complete corresponding source code from us for a period of three years after our last shipment of this product for a charge of 20\$ no more than the cost of preparing and mailing a DVD to you. Please contact info@minidsp.com. This offer is valid to anyone in receipt of this information.